

V O L V O



V O L V O

DIPLOMATIC
SALES

VOLVO V60



p 3	Volvo V60 offer
p 4-5	Designs
p 6-7	Essential standard equipment
p 8-9	Trim levels
p 10-11	Wheels
p 12	Metallic paint
p 13-15	Interior
p 16-17	Option packs
p 18	Accessory packs
p 19	Options
p 20-21	Accessories
p 23	Accessories for electric driving
p 24	Extended Services
p 25	Delivery Pack
p 26-27	Technical specifications

MADE BY | **SWEDEN**

VOLVO V60 OFFER

	Engines	Transmission	Design	Power output hp/kW	CO ₂ emissions g/km	Electric consumption kWh/100 km	Electric range up to km	List price € excl. VAT	List price € incl. VAT BE	List price € incl. VAT LU ⁽¹⁾
VOLVO V60										
ESSENTIAL										
Mild hybrid petrol	B4	DCT 7-speed	Base	197/145	140-156	–	–	37.181,82	44.990	43.503
Plug-in hybrid petrol	T6 AWD	Automatic 8-speed	Base	350/257	17-23	16,4	92	50.322,31	60.890	58.877
CORE										
Mild hybrid petrol	B4	DCT 7-speed	Base	197/145	140-156	–	–	38.834,71	46.990	45.437
Plug-in hybrid petrol	T6 AWD	Automatic 8-speed	Base	350/257	17-23	16,4	92	51.396,69	62.190	60.134
PLUS										
Mild hybrid petrol	B4	DCT 7-speed	Bright or Dark	197/145	143-156	–	–	43.793,39	52.990	51.238
Plug-in hybrid petrol	T6 AWD	Automatic 8-speed	Bright or Dark	350/257	17-23	16,5	92	55.611,57	67.290	65.066
Plug-in hybrid petrol	T8 AWD	Automatic 8-speed	Bright or Dark	455/335	17-23	16,5	92	57.842,98	69.990	67.676
ULTRA										
Mild hybrid petrol	B4	DCT 7-speed	Bright or Dark	197/145	144-156	–	–	47.925,62	57.990	56.073
Plug-in hybrid petrol	T6 AWD	Automatic 8-speed	Bright or Dark	350/257	17-23	16,6	91	59.165,29	71.590	69.223
Plug-in hybrid petrol	T8 AWD	Automatic 8-speed	Bright or Dark	455/335	17-23	16,6	91	61.396,69	74.290	71.834

Vehicles destined for EEA. The models listed above are destined for the European Economic Area ('EEA') market. Volvo Cars does not guarantee the compatibility of these models with any rules or regulations applicable outside the EEA. If you export these models outside of the EEA or if you request us to do so for you, such export will take place at your own risk.

Export of vehicles. Export outside of the country of purchase in any event occurs at your risk and cost. The prices listed above are exclusive of freight charges, taxes, licenses and any other documentation related to the export of your vehicle outside of the country of purchase. In case of export, the dealer will request you to deposit the amount of VAT applicable in the country of purchase as a guarantee. The dealer will reimburse the relevant amount to you upon receipt of (i) proof that you are exempted from VAT in the country where the vehicle is registered, or (ii) proof that VAT has been paid in the country where the vehicle is registered.

(1) Prices. A delivery fee of € 250 (excl. VAT) will be added to the prices listed above for vehicles supplied in the Grand Duchy of Luxembourg. The above-listed prices are furthermore exclusive of dealer preparation fees. Therefore, additional charges may be applied at your delivery point. Finally, you will be responsible for the payment of VAT (as applicable in the country of first registration of your vehicle) and any other taxes, as well as any registration and similar fees, all to the extent applicable. For ease of reference, VAT as currently applicable in Belgium and the Grand Duchy of Luxembourg are listed above.

The Volvo V60 has been approved in accordance with the World Harmonised Light Vehicle Test Procedure (WLTP), a new and more realistic test procedure for measuring the fuel consumption and CO₂ emissions of the car. The WLTP replaces the New European Driving Cycle test procedure, "NEDC", and takes account of the options and certain accessories in the care which have an impact on the weight and aerodynamics of the vehicle. Owing to the more realistic test conditions, the fuel consumption and CO₂ emissions measured in accordance with the WLTP are in many cases higher than those measured using the NEDC.



DESIGNS

BASE

For B4 and T6 AWD



BRIGHT

For B4 and T6/T8 AWD



DARK

For B4 and T6/T8 AWD



DESIGNS

BASE

Grille with chrome frame and Charcoal vertical strips

Bumpers front/rear with elements in Matt Black

Trim on side windows in black

Integrated roof rails in Glossy Black

17" wheels



BRIGHT

Glossy black grille with trim and vertical strips in chrome

Bumpers front/rear with elements in Charcoal and chrome inlays

Trim on side windows in chrome

Integrated roof rails in Chrome

18" wheels



DARK

Grille with sporty design, frame and horizontal strips in Glossy Black

Bumpers front/rear with sporty design and elements in Glossy Black

Trim on side windows in Glossy Black

Integrated roof rails in Glossy Black

Outer rear-view mirror caps in Glossy Black

18" wheels



ESSENTIAL STANDARD EQUIPMENT

ESSENTIAL

	Design	List price € excl. VAT	List price € incl. VAT BE	List price € incl. VAT LU	B4	T6 AWD	T8 AWD
V60 Essential equipment. Base design.	Base	0,00	0	0	S	S	-

S = Standard | - = Not available

SAFETY

Stability and traction control: Electronic Stability Control (ESC) including Active Yaw Control, Understeer Control Logic, Advanced Stability Control, Roll Stability Control, Driver Steering Recommendation, Sport Mode, Dynamic Torque Vectoring, Trailer Stability Assist (combined with the tow bar) and Hill Descent Control (with All Wheel Drive only) | Traction Control (TC) including Corner Traction Control with Torque Vectoring | Spin Control including Engine Drag Control.

Lane Keeping Aid: helps the driver to stay in lane (active from 65 km/h), including Run-off Road Mitigation: helps prevent the vehicle from running off the road, with steering aid and braking intervention (active between 65 and 140 km/h)

Oncoming Lane Mitigation: helps the driver to avoid collisions with vehicles coming in the opposite direction by automatically adjusting the steering & Oncoming Mitigation by Braking: automatic braking system attenuating the impact of a head-on collision

City Safety system: helps the driver to avoid or attenuate collisions with other vehicles (including those coming in the opposite direction at crossroads), cyclists, pedestrians and large animals (active up to a speed difference of 50 km/h, day and night), including automatic steering assistance (Steer Assist system active between 50 and 100 km/h) and active braking intervention

Driver Alert Control (DAC): system that detects and warns of tiredness

Connected Safety technology including Slippery Road Alert and Hazard Light Alert

Automatic braking after a collision

Indirect Tyre Pressure Monitoring System (iTPMS)

Ultra-resistant structure of vehicle interior and roof in boron steel

Collapsible steering column

Height-adjustable seat belts in front and with pre-tensioners and load limiters front and rear

Run-off Road Protection: protection if the vehicle leaves the road, with path correction (Run-off Road Mitigation), including energy-absorbing front seat cushions

Front airbags, SIPS® side airbags and inflatable curtains

WHIPS® (Whiplash Injury Protection System): provides protection against injuries due to whiplash thanks to specific energy-absorbing backrests and seats and head restraints integrated into the front seats

Brake Pedal Release: automatic release of brake pedal, by means of a pyrotechnic device, in the event of an accident to attenuate injuries to feet, legs and back

Emergency brake lights

Power-operated child safety lock on rear doors

Isofix anchorages for the outer positions of the rear seat

Front passenger airbag cut-off switch

DRIVER ASSISTANCE

Adaptive Cruise Control: can help you keep a certain distance with the vehicle in front at all speeds

Rear Park Assist Camera

Rear Park Assist with auto brake function

Cruise control (not with Adaptive cruise control)

Advanced Driver Assist System (ADAS) sensor platform

Intelligent Speed Assist (ISA)

Road Sign Information (RSI): display of road sign information

Ready to Drive notification: inform the driver via a sound and a visual notification if its car is still standing still even though the other car in front has moved a certain distance or exceeded a certain speed

Drive Modes: up to 4 modes (Comfort for mild hybrids and Hybrid/Pure/AWD/Power for plug-in hybrids) with different parameters for the use of the combustion and/or electrical engine, throttle response, automatic gearbox, start/stop function, optional all-wheel drive, assisted steering, brakes, climate control and optional adaptive cruise control

MULTIMEDIA & CONNECTIVITY

12,3" driver information display with two display modes: Calm and Navi

9" center display with touchscreen to control most of the functions

Google infotainment system with:

- Google Maps: navigation and public charging stations locator

- Google Assistant: voice assistant via "Hey Google" to control certain car functions, navigation, your smartphone, media, search for online information or control certain connected devices

- Google Play Store: access to a catalog of in-car apps to download and use in the car (such as Spotify®, Waze®, Amazon Prime Video® and YouTube®)

4-year data subscription for use of Google services and all apps. After that period, a paid extension of the data subscription will be available or you can share your data via your smartphone.

Remote functions via the Volvo Cars app on your smartphone, such as:

- launch and plan the preconditioning to cool/heat the cabin to comfort temperature and optimize your battery before departure

- (un)lock your car

- localize your car

- access to the Driving Journal

- plan and check the status of your electric charging session

Apple CarPlay® and Android Auto®: access to third developers apps such as Waze® and WhatsApp®

OTA: Over The Air updates for the car

Wireless charging for smartphone in the central tunnel (electromagnetic induction technology only) (not on T6/T8 AWD)

High Performance audio system with RDS radio, Internet radio, 10 speakers (4 tweeters, 2 mid-range and 4 woofers) and 220 W amplifier

DAB+ (Digital Audio Broadcasting)

4 USB-C connections: 2 in the central console and 2 at the rear of the tunnel console

Bluetooth® hands-free telephone system and audio streaming

Controls integrated into steering wheel for driver display, cruise control, audio, telephone, navigation system and voice commands

Integrated "SOS" button for assistance in life-threatening emergencies

Integrated "On Call" button for roadside assistance

Volvo Assistance | 3 years subscription included



BASE DESIGN

ESSENTIAL STANDARD EQUIPMENT

PERSONAL SAFETY AND CONVENIENCE

Keyless Start: starts the engine without a key

Electric parking brake with Auto Hold (automatic brake at a standstill) and Hill Start Assist (assistance to start on a hill or slope) functions

External and internal approach lighting, turned on when the vehicle is unlocked

Follow Me Home safety lighting

Remote-controlled central locking, automatic door locking > 7 km/h (to be activated from the menu) and automatic unlocking after a collision

Comfort closing: simultaneous locking/unlocking and closing/opening of all the doors and windows, as well as the optional sunroof

Immobiliser

Two remote controls, including one "Care Key" which allows you to set a lower maximal speed (<180 km/h)

Tyre repair kit

CLIMATE CONTROL

Two-zone electric automatic climate control system with air vents at the rear, humidity sensor, air recirculation function and pollen filter

Pre-ventilation and post-climatisation function for the interior of the vehicle when the engine is switched off

IAQS (Interior Air Quality System) to improve air quality inside the vehicle, with active filter

Front and rear wipers blades with integrated washers ("AquaBlades")

Rain sensor with adjustable sensitivity level

VERSATILITY

Ticket holder on driver's side of the windscreen

Flat load floor with rear seat backrest folded down

Luggage cover with load position function

Storage space beneath luggage compartment floor, with cargo dividers

Four folding load retainer eyelets in luggage compartment

Aluminium load sill protection

INTERIOR

Front lumbar support electrically adjustable in 2 directions, electrically operated height adjustment and with adjustable seat cushion tilt angle

City Weave textile upholstery

Rear seat with folding two-split 60/40 backrest and central armrest with load hatch for long objects

Folding rear head restraints

Aluminium front door sill moulding with Volvo logo

Textile floor mats at front and rear

Interior lighting Plus, including dimmed lighting at front and floor lights at front

Illuminated vanity mirrors at front

Height- and depth-adjustable steering wheel with Silk Metal inlay

Inner rear-view mirror without trim with automatic dimming

Active Noise Control with EOE (Engine Order Enhancement) (only on mild hybrid petrol engines)

EXTERIOR

LED headlights with integrated T-shaped daytime running lights, automatic level adjustment, Active High Beam and automatic headlights

LED rear lights

17" wheels (mild hybrids)

18" wheels (plug-in hybrids)

Dynamic chassis

Power retractable, heated outer rear-view mirrors with colour coordinated cap and integrated LED indicator

Roof spoiler

T6/T8 AWD PLUG-IN HYBRIDS ADDITIONAL STANDARD EQUIPMENT

PLUG-IN HYBRID

Preconditioning to cool/heat the cabin to comfort temperature

Predictive Efficiency: function that optimises the use of the electric engine and the battery capacity based on the destination entered

One Pedal Drive: possibility to use only one pedal to accelerate or brake - just by lifting the pedal the driver can, on a short distance, slow the car all the way to standstill not having to use the brake pedal

Acoustic Vehicle Alerting System (AVAS) at slow speed

Glossy black finish of the tunnel console

Air-ventilated subwoofer

Active Noise Control with EOE (Engine Order Enhancement) and EOR (Engine Order Reduction)

10A charging cable with Schuko socket (for domestic use), length 7 m

T6 AWD or T8 AWD emblem at rear



TRIM LEVELS

CORE

	Design	List price* € excl. VAT	List price* € incl. VAT BE	List price* € incl. VAT LU	B4	T6 AWD	T8 AWD
Includes the V60 Essential equipment supplemented by the specific V60 Core equipment. Base design.	Base	1.074,38	1.300	1.257	–	O	–
	Base	1.652,89	2.000	1.934	O	–	–

*Supplement already included in the prices per trim level as shown on page 3.

O = Option | – = Not available

Power-operated tailgate

Front Park Assist

Heated front seats, rear seats and steering wheel

Keyless Entry: passive (un)locking, hands-free opening/closing of tailgate (foot movement under the rear bumper), LED entry lighting integrated in the door handles

Power folding rear head restraints

Storage nets in backrest of front seats, nylon safety net between the back seats and the luggage compartment

Luggage compartment: 12 V socket on the right-hand side, storage net on the left-hand side and grocery bag holder with elastic strap (hidden in the floor)

Outer rear-view mirrors without trim with automatic anti-glare function



**BASE
DESIGN**

PLUS

	Design	List price* € excl. VAT	List price* € incl. VAT BE	List price* € incl. VAT LU	B4	T6 AWD	T8 AWD
Includes the V60 Core equipment supplemented by the specific V60 Plus equipment. Bright or Dark design.	Bright or Dark	5.289,26	6.400	6.188	–	O	S
	Bright or Dark	6.611,57	8.000	7.736	O	–	–

*Supplement already included in the prices per trim level as shown on page 3.

O = Option | S = Standard | – = Not available

18" alloy wheels (mild hybrids)

Driver Assistance with:

- Pilot Assist: enables empowered driving on motorways and roads with side ground marking up to a speed of 130 km/h
- Emergency Stop Assist: can bring the vehicle to a complete stop in lane in situations where the driver is not responding to hands-off warnings

Driver Awareness with:

- BLIS (Blind Spot Information System with steering assistance)
- Rear Collision Warning with automatic emergency braking
- Cross Traffic Alert: detection of vehicles coming from the side when reversing

Harman Kardon audio system with 14 speakers (4 tweeters, 5 mid-range, 2 woofers, 2 full-range surround and 1 ventilated subwoofer) and 12-channel 600W amplifier

Moritz leather upholstery

Power-operated front passenger seat

Power-operated driver seat with memory function for seat position and outer rear-view mirrors position (incl. automatic angling during parking)

Power-operated four-way lumbar support in front seats

Memory function for front passenger seat position

Front seats with seat cushion extension and additional adjustment of the inclination for passenger seat cushion (manual extension in combination with manual seat(s), motorized in combination with electric seat(s))

Air purifier (incl. Advanced air cleaner, Advanced filter, AQS and PM 2.5 sensor (APMS)) which removes up to 95% of all harmful PM 2.5 particles and pollen from the air in the car. Control and statistics via the central display or the Volvo Cars app

Full LED directional headlights with adaptive automatic main beam (Active High Beam II)

LED front fog lights (not available on T6/T8 AWD)

High-pressure headlight washers

Interior lighting Pro (very generous amount of interior lighting including dimmed lighting at front and rear)



**BRIGHT
DESIGN**

OR

**DARK
DESIGN**

TRIM LEVELS

ULTRA

	Design	List price* € excl. VAT	List price* € incl. VAT BE	List price* € incl. VAT LU	B4	T6 AWD	T8 AWD
Includes the V60 Plus equipment supplemented by the specific V60 Ultra equipment. Bright or Dark design.	Bright or Dark	3.553,72	4.300	4.158	–	–	O
	Bright or Dark	8.842,98	10.700	10.346	–	O	–
	Bright or Dark	10.743,80	13.000	12.570	O	–	–

*Supplement already included in the prices per trim level as shown on page 3.

O = Option | – = Not available

Tilt and slide panoramic sunroof with integrated power-operated sun curtain

Four-zone electronic automatic climate control with additional air vents at the rear of the tunnel console (not available on T6/T8 AWD)

Head-up display, including Distance Alert

Upper part of the dashboard covered in simili-leather

360° Park Assist Camera with bird's-eye view incl. Park Assist front, rear and side (replaces standard Front Park Assist and Rear Park Assist Camera)







BRIGHT
DESIGN

OR

DARK
DESIGN



PLUG-IN HYBRID WHEELS

		List price € excl. VAT	List price € incl. VAT BE	List price € incl. VAT LU	ESSENTIAL	CORE	PLUS	ULTRA
18" ALLOY WHEELS								
	- 18" 5-double spoke silver 235/45 R18 tyres W	0,00	0	0	●	●	-	-
	1233 18" 10-multiple spoke black/diamond cut 235/45 R18 tyres W	0,00	0	0	-	-	●Bright/_Dark	●Bright/_Dark
	1352 18" 5-double spoke black/diamond cut 235/45 R18 tyres W	157,02	190	184	○	○	_Bright/●Dark	_Bright/●Dark
19" ALLOY WHEELS								
	1253 19" 6 spoke black/diamond cut 235/40 R19 W tyres with Cavity Noise Dampening	818,18	990	957	○	○	○	○
	1236 19" 5-triple spoke black/diamond cut 235/40 R19 W tyres with Cavity Noise Dampening	818,18	990	957	-	-	○	○







○ = Option | ● = Included in trim level | - = Not available



MILD HYBRID WHEELS

		List price € excl. VAT	List price € incl. VAT BE	List price € incl. VAT LU	ESSENTIAL	CORE	PLUS	ULTRA
17" ALLOY WHEELS								
	- 17" 5-double spoke silver 225/50 R17 V tyres	0,00	0	0	●	●	-	-
	1232 17" 5-Y spoke black/diamond cut 225/50 R17 V tyres	157,02	190	184	○	○	-	-
18" ALLOY WHEELS								
	1233 18" 5-multi spoke black diamond cut Alloy wheel	0,00	0	0	-	-	●Bright/_Dark	●Bright/_Dark
	1234 18" 5 spoke black/diamond cut 235/45 R18 tyres W	735,54	890	861	○	○	_Bright/●Dark	_Bright/●Dark
19" ALLOY WHEELS								
	1236 19" 5-triple spoke black/diamond cut 235/40 R19 W tyres with Cavity Noise Dampening	818,18	990	957	-	-	○	○
	1100 19" 5-aerospoke black/diamond cut 235/40 R19 W tyres with Cavity Noise Dampening	1.421,49	1.720	1.663	○	○	-	-
20" ALLOY WHEELS								
	800145 20" 10-Turbine spoke black/diamond cut 245/35 R20 W tyres with Cavity Noise Dampening (only with option 26)	1.479,34	1.790	1.731	-	-	○	○

METALLIC PAINT

		List price € excl. VAT	List price € incl. VAT BE	List price € incl. VAT LU	ESSENTIAL	CORE	PLUS	ULTRA
	740 Vapour Grey Metallic	0,00	0	0	●	●	●	●
	717 Onyx Black Metallic	818,18 487,60	990 590	957 570	0 -	- 0	- 0	- 0
	723 Denim Blue Metallic	818,18 487,60	990 590	957 570	0 -	- 0	- 0	- 0
	736 Bright Dusk Metallic	818,18 487,60	990 590	957 570	0 -	- 0	- 0	- 0
	707 Crystal White Pearl Metallic	818,18 487,60	990 590	957 570	0 -	- 0	- 0	- 0
	745 Aurora Silver Metallic	818,18 487,60	990 590	957 570	0 -	- 0	- 0	- 0
	746 Forest Lake Metallic	818,18 487,60	990 590	957 570	0 -	- 0	- 0	- 0

O = Option | ● = Included in trim level | - = Not available

INTERIOR

	List price € excl. VAT	List price € incl. VAT BE	List price € incl. VAT LU	ESSENTIAL	CORE	PLUS	ULTRA
COMFORT SEATS, CITY WEAVE TEXTILE							
R7D0 Interior base colour and colour steering wheel: Charcoal	0,00	0	0	●	●	-	-
Colour seats: Charcoal							
Colour headlining: Blond							
Inlays dashboard: aluminium Iron Ore							
Gear lever knob covered in simili-leather with Silk Metal inlay							
Steering wheel covered in simili-leather and integrated controls in Charcoal							
COMFORT SEATS, MORITZ LEATHER							
RA00 Interior base colour and colour steering wheel: Charcoal	1.231,40	1.490	1.441	○	○	●	●
Colour seats: Charcoal							
Colour headlining: Blond							
Inlays dashboard and central console: Metal Mesh aluminium							
Gear lever knob covered in simili-leather with Silk Metal inlay							
Steering wheel covered in simili-leather and integrated controls in Charcoal (Essential/Core) or Glossy Black (Plus/Ultra)							
UA00 Interior base colour and colour steering wheel: Blond/Charcoal	1.355,37	1.640	1.586	○	○	-	-
Colour seats: Blond	0,00	0	0	-	-	○	○
Colour headlining: Blond							
Inlays dashboard and central console: Drift Wood							
Gear lever knob covered in simili-leather with Silk Metal inlay							
Steering wheel covered in leather and integrated controls in Glossy Black							



RA00



UA00



RA00



UA00



RA00



UA00

○ = Option | ● = Included in trim level | - = Not available

INTERIOR

	List price € excl. VAT	List price € incl. VAT BE	List price € incl. VAT LU	ESSENTIAL	CORE	PLUS	ULTRA
SPORT SEATS, NAPPA LEATHER/OPEN GRID TEXTILE/SIMILI-LEATHER							
RGOR Interior base colour and colour steering wheel: Charcoal	404,96	490	474	–	–	0	0
Colour seats: Charcoal							
Colour headlining: Charcoal							
Inlays dashboard and central console: aluminium Metal Mesh							
Crystal gearshifter, hand made by Swedish glass maker Orrefors®							
Sport steering wheel covered in simili-leather with stitching and integrated controls in Glossy Black							
COMFORT SEATS, VENTILATED NAPPA LEATHER*							
RC00 Interior base colour and colour steering wheel: Charcoal	1.644,63	1.990	1.924	–	–	0	0
Colour seats: Charcoal							
Colour headlining: Blond							
Inlays dashboard, doors and central console: Drift Wood							
Crystal gearshifter, hand made by Swedish glass maker Orrefors®							
Steering wheel covered in simili-leather and integrated controls in Glossy Black (Ultra: only with 384 massage function)							



RGOR



RC00



RGOR



RC00



RGOR



RC00

*Includes lateral support for electric seats at front-ventilated and perforated seats only at front.

0 = Option | – = Not available

INTERIOR

		List price € excl. VAT	List price € incl. VAT BE	List price € incl. VAT LU	ESSENTIAL	CORE	PLUS	ULTRA
COMFORT SEATS, VENTILATED NAPPA LEATHER*								
RC20	Interior base colour and colour steering wheel: Charcoal Colour seats: Amber Colour headlining: Charcoal Inlays dashboard and central console: Linear Lime Walnut wood Crystal gearshifter, hand made by Swedish glass maker Orrefors® Steering wheel covered in simili-leather and integrated controls in Glossy Black (Ultra: only with 384 massage function)	1.644,63	1.990	1.924	-	-	0	0
UC00	Interior base Colour: Blond/Charcoal Colour seats: Blond Colour headlining: Blond Inlays dashboard and central console: Drift Wood Crystal gearshifter, hand made by Swedish glass maker Orrefors® Steering wheel covered in leather and integrated controls in Glossy Black (Ultra: only with 384 massage function)	1.644,63	1.990	1.924	-	-	0	0



*Includes lateral support for electric seats at front - ventilated and perforated seats only at front.

0 = Option | - = Not available

OPTION PACKS

	List price € excl. VAT	List price € incl. VAT BE	List price € incl. VAT LU	ESSENTIAL	CORE	PLUS	ULTRA
DRIVER ASSIST PACK							
1162 Driver Assistance with: - Pilot Assist: enables empowered driving on motorways and roads with side ground marking up to a speed of 130 km/h - Emergency Stop Assist: can bring the vehicle to a complete stop in lane in situations where the driver is not responding to hands-off warnings	603,31	730	706				
169 Interior rear-view mirror without trim, with automatic anti-glare function (standard from Core)	347,11	420	406				
603 Driver Awareness with: - BLIS (Blind Spot Information System with steering assistance) - Rear Collision Warning with automatic emergency braking - Cross Traffic Alert: detection of vehicles coming from the side when reversing	495,87	600	580				
Total value of equipment	1.446,28	1.750	1.692				
Diplo Pack advantage	-462,81	-560	-541				
P0005 DRIVER ASSIST PACK	983,47	1.190	1.151	0	-	●	●
Total value of equipment	1.099,17	1.330	1.286				
Diplo Pack advantage	-280,99	-340	-329				
P0005 DRIVER ASSIST PACK	818,18	990	957	-	0	●	●

WINTER PACK							
11 Heated front seats	322,31	390	377				
752 Heated rear seats (outer seating positions)	297,52	360	348				
869 Heated steering wheel	206,61	250	242				
Total value of equipment	826,45	1.000	967				
Diplo Pack advantage	-173,55	-210	-203				
P0008 WINTER PACK	652,89	790	764	0	●	●	●

LIGHT PACK							
16 LED front fog lights (not on T6/T8 AWD*)	181,82	220	213				
65 High-pressure headlight washers	247,93	300	290				
645 Full LED directional headlights with adaptive automatic main beam (Active High Beam II)	752,07	910	880				
879 Interior lighting Pro (very generous amount of interior lighting including dimmed lighting at front and rear)	82,64	100	97				
Total value of equipment	1.264,46	1.530	1.479				
Diplo Pack advantage	-280,99	-340	-329				
P0004 LIGHT PACK	983,47	1.190	1.151	-	0	●	●

*Pack advantage incl. VAT T6/T8 AWD: -€ 160

LUXURY SEAT PACK*							
10 Power-operated front passenger seat	363,64	440	425				
47 Power-operated driver seat with memory function for seat position and outer rear-view mirrors position (incl. automatic angling during parking)	652,89	790	764				
212 Power-operated four-way lumbar support in front seats	123,97	150	145				
385 Memory function for front passenger seat position	82,64	100	97				
1101 Front seats with seat cushion extension and additional adjustment of the inclination for passenger seat cushion	157,02	190	184				
Total value of equipment	1.380,17	1.670	1.615				
Diplo Pack advantage	-314,05	-380	-367				
P0001 LUXURY SEAT PACK	1.066,12	1.290	1.247	-	0	●	●

*Only with leather upholstery

OPTION PACKS

	List price € excl. VAT	List price € incl. VAT BE	List price € incl. VAT LU	ESSENTIAL	CORE	PLUS	ULTRA
TECH PACK							
139 360 degree camera	570,25	690	667				
1033 Harman Kardon audio	735,54	890	861				
1074 Air purifier	239,67	290	280				
Total value of equipment	1.545,45	1.870	1.808				
Diplo Pack advantage	-314,05	-380	-367				
P0063 Tech Pack	1.231,40	1.490	1.441	-	○	-	●

PREMIUM PACK							
139 360 degree camera	570,25	690	667				
30 Panoramic sunroof	1.231,40	1.490	1.441				
117 Head-up display with Distance Alert function (not with option 871 Heated windscreen with power-operated defrosting function)	818,18	990	957				
Total value of equipment	2.619,83	3.170	3.065				
Diplo Pack advantage	-561,98	-680	-658				
P0065 PREMIUM PACK	2.057,85	2.490	2.408	-	-	○	●

LOUNGE PACK							
553 Bowers & Wilkins audio	1.975,21	2.390	2.311				
384 Front seats massage	487,60	590	570				
RC00/RC20/UC00 Nappa ventilated upholstery, of choice	1.644,63	1.990	1.924				
Total value of equipment	4.107,44	4.970	4.806				
Diplo Pack advantage	-809,92	-980	-948				
P0066 LOUNGE PACK	3.297,52	3.990	3.858	-	-	○	○

○ = Option | ● = Included in trim level | - = Not available



ACCESSORY PACKS

	List price € excl. VAT	List price € incl. VAT BE	List price € incl. VAT LU	V60
PROTECTION PACK				
A00112 Moulded plastic load compartment protection	128,10	155	150	
A00456 Bumper cover made of stainless steel	140,50	170	164	
A00492 / A01291 Rubber floor mat front and rear	119,83	145	140	
A00217 Anti-theft wheel locks	57,85	70	68	
Total value of equipment	446,28	540	522	
Diplo Pack advantage	-90,91	-110	-106	
PA001 PROTECTION PACK	355,37	430	416	O
TRAVEL PACK				
A01813 Black transversal roof bars	289,26	350	338	
A01241 Roofbox 'Travel Active 500', glossy black (500L, 215x92x44 cm)	756,20	915	885	
Total value of equipment	1.045,45	1.265	1.223	
Diplo Pack advantage	-136,36	-165	-160	
PA103 TRAVEL PACK	909,09	1.100	1.064	O
CONVENIENCE PACK				
A00087 Glasses holder	49,59	60	58	
A00106 Luggage net to be attached to load securing eyelets	57,85	70	68	
A01435 Neck pillow	74,38	90	87	
A01247 Charging cable storage bag (not included for B4)	57,85	70	68	
Total value of equipment	239,67	220	280	
Diplo Pack advantage	-132,23	-90	-155	
PA003 CONVENIENCE PACK	107,44	130	126	O/-T6/T8
Total value of equipment	239,67	290	280	
Diplo Pack advantage	-82,64	-100	-97	
PA003 CONVENIENCE PACK	157,02	190	184	-/O ^{T6/T8}
KIDS PACK				
A01507 Volvo rear-facing child seat	516,53	625	604	
A00096 Kids Guard	66,12	80	77	
Total value of equipment	582,64	705	682	
Diplo Pack advantage	-61,98	-75	-73	
PA005 KIDS PACK	520,66	630	609	O

O = Option | - = Not available | T6/T8 = Only for T6/T8 AWD

OPTIONS

		List price € excl. VAT	List price € incl. VAT BE	List price € incl. VAT LU	ESSENTIAL	CORE	PLUS	ULTRA
DRIVER ASSISTANCE								
117	Head-up display with Distance Alert function (not with option 871 Heated windscreen with power-operated defrosting function)	818,18	990	957	-	-	O	●
139	360° Park Assist Camera with bird's-eye view incl. Park Assist front, rear and side (replaces standard Front Park Assist and Rear Park Assist Camera)	570,25	690	667	-	O	O	●
691	Front Park Assist	239,67	290	280	O	●	●	●
26	Sport chassis lowered by 12 mm with stiffer, sport suspension (only with 20" wheels)	322,31	390	377	-	-	O/-T6/T8	O/-T6/T8
SAFETY & PROTECTION								
140	Volvo Guard alarm with movement and inclination sensor	487,60	590	570	O	O	O	O
165	Temporary spare wheel, T125/80 R18 (replaces the tyre repair kit)	157,02	190	184	O/-T6	O/-T6	O/-T6/T8	O/-T6/T8
236	Laminated side and rear windows	735,54	890	861	-	-	-	O
EXTERIOR								
30	Tilt and slide panoramic sunroof with integrated power-operated sun curtain	1.231,40	1.490	1.441	-	-	O	●
179	Dark tinted glass for rear windows (80% darkening)	404,96	490	474	-/O ^{T6}	O	O	O
SEATS								
384	Massage function in front seats (only with interior xCx0)	487,60	590	570	-	-	O	O
CLIMATISATION								
871	Heated windscreen with power-operated defrosting function (not with option 117 Head-up display)	239,67	290	280	-	O	O	-
PACK & LOAD								
1028	Semi-automatic retractable tow bar with 13-pin socket (includes Trailer Stability Assist system)	983,47	1.190	1.151	O	O	O	O
AUDIO								
1033	Harman Kardon audio system with 14 speakers (4 tweeters, 5 mid-range, 2 woofers, 2 full-range surround and 1 ventilated subwoofer) and 12-channel 600W amplifier	735,54	890	861	-	O	●	●
553	Bowers & Wilkins audio system with 15 speakers (1 tweeter-on-top, 4 tweeters, mid-range, 2 bass/mid-range, 2 full-range surround, 2 woofers and 1 ventilated subwoofer) and 15-channel 1410W amplifier	1.975,21	2.390	2.311	-	-	O	O
PLUG-IN HYBRID								
994	16 A charging cable cord with CEE socket (for blue industrial socket), length 7 metres (replaces the standard charging cable, not with option 1248)	0,00	0	0	-/O ^{T6}	-/O ^{T6}	-/O ^{T6} /T8	-/O ^{T6} /T8
1248	16 A charging cable, Mode 3, with Mennekes socket (for charging point), length 6 metres (replaces the standard charging cable, not with option 994)	0,00	0	0	-/O ^{T6}	-/O ^{T6}	-/O ^{T6} /T8	-/O ^{T6} /T8

O = Option | ● = Included in trim level | - = Not available | T6/T8 = Only for T6/T8 AWD



ACCESSORIES

		List price € excl. VAT	List price € incl. VAT BE	List price € incl. VAT LU	V60
LUGGAGE COMPARTMENT					
A00112	Moulded plastic load compartment protection	128,10	155	150	O
A00382	Reversible and foldable load compartment floor mat	181,82	220	213	O
A00189	Steel protective grille between the load compartment and the rear seat; can be folded up to the roof	252,07	305	295	O
A00106	Luggage net to be attached to load securing eyelets	57,85	70	68	O
COMFORT					
A00492	Rubber floor mat front and rear	119,83	145	140	O/-T6/T8
A01291	Rubber floor mat front and rear	119,83	145	140	-/OT6/T8
A00744	Sunshade for windscreen	119,83	145	140	O
A00087	Glasses holder	49,59	60	58	O
A00530	Ashtray	37,19	45	44	O
A01130	Front seat cover	119,83	145	140	O
A00763	Nubuck neck cushion (Blond)	57,85	70	68	O
A00769	Textile cushion (Charcoal)	57,85	70	68	O
A00770	Leather cushion (Charcoal)	78,51	95	92	O
A00771	Leather cushion (Blond)	78,51	95	92	O

O = Option | - = Not available | T6/T8 = Only for T6/T8 AWD



ACCESSORIES

	List price € excl. VAT	List price € incl. VAT BE	List price € incl. VAT LU	V60
EXTERIOR STYLING				
A00456 Bumper cover made of stainless steel	140,50	170	164	0
ADVENTURE				
A00463* Preparation for mounting tow bar as accessory	0,00	0	0	0
A00463* Semi-automatic retractable tow bar with 13-pin outlet (Trailer Stability Assist system included)	983,47	1.190	1.151	0
A00017 Adapter for extra bike (only in combination with A01239)	128,10	155	150	0
A01238 Folding bicycle holder on tow bar for two bicycles (Fix4Bike)	685,95	830	803	0
A01239 Bicycle holder on tow bar for three bicycles (Fix4Bike)	710,74	860	832	0
A01813 Black transversal roof bars	289,26	350	338	0
A01240 Roofbox 'Travel 400', glossy black (400L, 175x87x46 cm)	665,29	805	778	0
A01241 Roofbox 'Travel Active 500', glossy black (500L, 215x92x44 cm)	756,20	915	885	0
A01399 Roofbox 'Travel Premier 430', glossy black (430L, 223x94x30 cm), with LED lighting	962,81	1.165	1.126	0
A00025 Bicycle holder with frame bracket (aluminium), to be fitted on load carrier (1 bicycle)	128,10	155	150	0
A00221 Ski holder, (4 pairs of skis) to mount on roof bars	161,16	195	189	0
A00219 Ski holder, (6 pairs of skis) to mount on roof bars	210,74	255	247	0
A01143 Retractable ski holder, to mount on roof bars	185,95	225	218	0
A01637 Lock kit - one key system	61,98	75	73	0
A00631 Jumper Cables	49,59	60	58	O/-T6/T8
A01601 Roof tent	2.272,73	2.750	2.659	0
A01595 Tow Cargo box (+holder)	1.157,02	1.400	1.354	0
A01594 Roof basket	454,55	550	532	0
A01624 Roof basket extender	165,29	200	193	0
A01593 Kayak holder	371,90	450	435	0
CHILD SAFETY				
A00096 Kick guard with storage pockets	66,12	80	77	0
A01507 Volvo rear-facing child seat	516,53	625	604	0
A01591 Seat Boost	330,58	400	387	0
SECURITY & PROTECTION				
A01251 Mini remote control 'Sport Key'	181,82	220	213	0
A00604 Dog harness	119,83	145	140	0
A00217 Anti-theft wheel locks	57,85	70	68	0
A00164* Front mud flaps	78,51	95	92	0
A00165* Rear mud flaps	78,51	95	92	0
A00330* Aluminium protection under the engine, the sump and the gearbox	342,98	415	401	0
A00228 AutoSock (snow socks)	107,44	130	126	0
A00227 Centrax snow chains (for 17" and 18" wheels)	342,98	415	401	0
A01327 e-mirror	739,67	895	865	0
A01250 Dashcam front	289,26	350	338	0
A01497 Dashcam front and rear	471,07	570	551	0
WHEELS				
A00903 Winter wheel kit 17", 5 double Spoke Silver with winter tyres 225/50 R17	1.735,54	2.100	2.031	O/-T6/T8
A00958 Winter wheel kit 18", 5 Y-Spoke Black/Diamond Cut with winter tyres 235/45 R18	1.995,87	2.415	2.335	-/OT6/T8
A01222 Winter wheel kit 18", 5 double Spoke Matt Black/Diamond Cut with winter tyres 215/55 R18	1.995,87	2.415	2.335	0
A00899 Winter wheel kit 19", 5 multiple Spoke Black/Diamond Cut with winter tyres 235/40 R19	2.388,43	2.890	2.794	0
A00898 Winter wheel kit 20", 5 triple Spoke Matt Black/Diamond Cut with winter tyres 245/35 R20	2.735,54	3.310	3.201	O/-T6/T8

*Accessories that impact on the weight and aerodynamics of the car and consequently the fuel consumption and CO₂ emissions measured in accordance with the WLTP.

O = Option | - = Not available |
T6/T8 = Only for T6/T8 AWD



ACCESSORIES FOR ELECTRIC DRIVING

Discover our range of accessories specially designed for electric vehicles. Offering both performance, comfort, and style, these products are perfect for enhancing your driving experience. Explore innovative solutions that adapt to your needs and optimize your vehicle's range and practicality.



VOLVO WALLBOX AND ACCESSORIES

We are excited to introduce our brand-new charging station, now available to support your electric journeys. Designed for fast and convenient charging, it's the perfect companion to ensure a seamless experience at home. Take advantage of this innovative solution, easy to install, so you're always ready to hit the road.



	List price € excl. VAT	List price € incl. VAT BE	List price € incl. VAT LU	V60
VOLVO WALLBOX				
A01815 Wallbox Bi-directional without cable	1.818,18	2.200	2.127	-/O ^{T6/T8}
A01814 Volvo wallbox with integrated cable	1.900,83	2.300	2.224	-/O ^{T6/T8}
A01816 Wallbox Bi-directional without cable + MID	2.024,79	2.450	2.369	-/O ^{T6/T8}
A01627 RTM Load balancer	140,50	170	164	-/O ^{T6/T8}

*Indicative pricing for charging station with 1 fixed cable of 7 m (A01814) or socket (A01815) and MID module (A01816). This prices includes a standard installation includes an installation check by phone, wall or pole mounted (max 1 meter ground works), circuit breaker, fuses, 12m cable, 12m data cable, 12m tube, explanation, electric scheme, legal control. No demolition or excavation works included. Final price through a custom offer based on a phone call or an on-site visit if necessary.

O = Option |
- = Not available |
T8 = Only for
T8 AWD



	List price € excl. VAT	List price € incl. VAT BE	List price € incl. VAT LU	V60
ADDITIONAL ACCESSORIES				
A01247 Charging cable storage bag	57,85	70	68	-/O ^{T6/T8}
A01150 Charging cord 1P 10A with Schuko socket (for domestic use), length 7 metres	363,64	440	425	-/O ^{T6/T8}
A01152 Charging cord 1P 16A with CEE socket (for blue industrial socket, 3 pins), length 7 metres	363,64	440	425	-/O ^{T6/T8}
A01154 Charging cord 1P 16A mode 3 (type 2) with Mennekes socket (for charging point), length 7 metres	363,64	440	425	-/O ^{T6/T8}
A01355 Charging cord 3P 16A mode 3 (type 2) with Mennekes socket (for charging point), length 6 metres	363,64	440	425	-/O ^{T6/T8}
A01354 Charging cord 3P 16A with CEE socket (for red industrial socket, 5 pins), length 6 metres	454,55	550	532	-/O ^{T6/T8}

O = Option | - = Not available | T6/T8 = Only for T6/T8 AWD

EXTENDED SERVICES

VOLVO CAR EXTENDED WARRANTY

Drive with **peace of mind**

When you buy a Volvo, you are choosing top quality, safety and reliability. Not only because you are buying a quality vehicle, but also because your Volvo dealer offers you the best service.

An extension of the factory guarantee protects you against high costs in the event of unexpected defects. Thanks to the very comprehensive coverage, you can drive your Volvo for an additional 3 years without any worries when your Volvo manufacturer's warranty expires after 2 years.

Volvo Car Extended Warranty protects you against unforeseen repair costs, even after the Volvo manufacturer's warranty has expired.

GUARANTEED LIQUIDITY IN CASE OF REPAIRS

And extensive repair costs reimbursement outside the manufacturer's warranty

VALID ANYWHERE IN EUROPE

The extended warranty can also be transferred to the next owner

USE OF GENUINE VOLVO PARTS

And repaired by Volvo-trained personnel: your Volvo remains in optimal condition

	List price € excl. VAT	List price € incl. VAT BE	List price € incl. VAT LU	V60
EXTENDED WARRANTY				
A00906 Volvo Car Extended Warranty + 1 year, limited to 200.000 km	371,90	450	435	O
A00907 Volvo Car Extended Warranty + 2 years, limited to 200.000 km	739,67	895	865	O
A00908 Volvo Car Extended Warranty + 3 years, limited to 200.000 km	1.095,04	1.325	1.281	O

O = Option

VOLVO CAR SERVICE PLAN

Plan in advance for a greater peace of mind

Rest assured with Volvo Cars' official maintenance programme. You pay a one-time premium when you sign the Volvo Car Service Plan contract and you no longer have to worry about the maintenance of your Volvo. Our technicians, trained by us, will maintain your car and keep it in perfect condition for years. All parts to be replaced, according to Volvo's official maintenance schedule, are included. So you'll never be faced with financial surprises.

VOLVO CAR SERVICE PLAN

- Volvo Car Service according to schedules maintenance intervals
 - health-check
 - software update
- renewal of your Volvo Assistance
- windshield washer fluid top-up 2x/year
- car wash, if available at the chosen Volvo authorised workshop

VOLVO CAR SERVICE PLAN PLUS

An extension of the Service Plan that also includes the following wear parts:

- brake pads
- brake discs
- wiper blades
- 12V battery

	List price € excl. VAT	List price € incl. VAT BE	List price € incl. VAT LU	V60
SERVICE PLAN				
A00739 Volvo Car Service Plan 3 years, limited to 90.000 km	1.152,89	1.395	1.349	O
A00973 Volvo Car Service Plan 4 years, limited to 120.000 km	1.731,40	2.095	2.026	O
A00740 Volvo Car Service Plan 5 years, limited to 150.000 km	2.066,12	2.500	2.417	O
A00741 Volvo Car Service Plan Plus 3 years, limited to 90.000 km	1.731,40	2.095	2.026	O
A00974 Volvo Car Service Plan Plus 4 years, limited to 120.000 km	3.285,12	3.975	3.844	O
A00742 Volvo Car Service Plan Plus 5 years, limited to 150.000 km	3.719,01	4.500	4.351	O

O = Option

DELIVERY PACK

VOLVO CAR DELIVERY PACK

Enjoy a **personalized delivery**

The delivery of a new car is a special moment. And Volvo makes this moment even more special. With the Delivery Pack, we provide a personalized unveiling of your new Volvo followed by a detailed explanation during and after delivery. Of course, we make sure your car is fully roadworthy and equipped to enjoy the Volvo experience right away.



- 5 safety vests
- fire extinguisher
- warning triangle
- front numberplate

- 20 liters of petrol and/or car charged to at least 80%
- detailed explanation of all car features

- Volvo Cars app setup
- car delivered under cover
- 1 hour follow-up meeting for all your questions after delivery

	List price € excl. VAT	List price € incl. VAT BE	List price € incl. VAT LU
DELIVERY PACK			
DELIV01 Volvo Car Delivery Pack	371,90	450	435

TECHNICAL SPECIFICATIONS

ENGINE	T6 AWD	T8 AWD
Engine code	B4204T52 (H4)	B4204T56 (H7)
Engine type	Plug-in hybrid petrol	Plug-in hybrid petrol
Electric engine battery	Lithium-ion 426V	Lithium-ion 426V
Battery energy capacity (nominal) kWh	18,8	18,8
Battery energy capacity (usable) kWh	14,7	14,7
Max. capacity petrol hp/kW/rpm	253/186/5.500	310/228/6.000
Max. capacity electric hp/kW/rpm	145/107/15.900	145/107/15.900
Max. capacity combined hp/kW	350/257	455/335
Max. torque petrol Nm/rpm	350/2.600-5.000	400/3.000-4.800
Max. torque electric Nm/rpm	309/0-3.280	309/0-3.280
Cylinders/valves/taxable horsepower	4 cylinder line/16/11	4 cylinder line/16/11
Supercharge	Turbo & 40kW starter/generator	Turbo & 40kW starter/generator
Cubic capacity (cc)	1.969	1.969
Bore & stroke (mm)	82 x 93,2	82 x 93,2
Compression ratio	10,3:1	10,3:1
Emissions standard	EURO 6e	EURO 6e
TRANSMISSION		
Motricity	Front wheel drive (combustion engine) & Rear wheel drive (electric motor)	Front wheel drive (combustion engine) & Rear wheel drive (electric motor)
Gearbox	Automatic 8-speed	Automatic 8-speed
PERFORMANCES		
Acceleration 0-100 km/h (sec)	5,4	4,6
Top speed (km/h)	180 / 140 (PURE mode)	180 / 140 (PURE mode)
PLUG-IN HYBRID		
On-board charger (kW)	6,4 (2 phase)	6,4 (2 phase)
Charge time 0-100% (16A/10A) 230V (hours)	3 / 4	3 / 4
EMISSIONS AND CONSUMPTION ACCORDING TO WLTP *		
Fuel consumption (combined) l/100 km	0,7 - 1,0	0,8 - 1,0
Electric power consumption (combined) kWh/100km	16,4 - 18,7	16,5 - 18,7
Electric range (combined) km	92 - 75	92 - 75
CO ₂ emissions (combined) g/km	17 - 23	17 - 23
WEIGHTS AND MEASURES		
Min. curb weight (kg)	1.994	1.994
Running order weight (kg)	2.064	2.064
Max. total weight (kg)	2.530	2.530
Max. braked / unbraked trailer (kg)	2.000 / 750	2.000 / 750
Max. roof load capacity (kg)	75	75
Largest load volume with bench seat back folded down ISO V214-1 (incl. V209) (liters)	1.431	1.431
Load compartment volume ISO V214-2 (incl. V209) (liters)	648	648
Load compartment volume under luggage cover ISO V211-2 (incl. V209) (liters)	519	519
Volume under load compartment floor (with / without spare wheel) ISO V209 (liters)	- / 9	- / 9
Fuel tank capacity (litres)	60	60

DIMENSIONS

EXTERIOR

Length x width x height (empty) on B4	477,8 x 185,0 x 143,7 cm
Length x width x height (empty) on T6/T8 AWD	477,8 x 185,0 x 143,0 cm
Wheelbase	287,2 cm
Front track with 17" / 18"-19" / 20"	160,3 / 160,0 / 159,3 cm
Rear track with 17" / 18"-19" / 20"	160,3 / 160,0 / 159,3 cm
Turning circle between curbs with 17" / 18"-19" / 20"	11,0 / 11,3 / 11,7 m
Ground clearance (driver included) / Forging depth on B4	14,2 / 25,0 cm
Ground clearance (driver included) / Forging depth on T6/T8 AWD	13,8 / 25,0 cm

INTERIOR

Headroom with sunroof front/rear	94,9 cm / 96,7 cm
Headroom without sunroof front/rear	97,6 cm / 96,6 cm
Shoulder room front/rear	142,5 / 138,4 cm
Leg room front/rear	107,4 / 89,5 cm
Min./max. length luggage compartment rear seats-tailgate	81,5 / 103,3 cm
Min./max. length luggage compartment front seats-tailgate	169,4 / 182,1 cm
Height luggage compartment	73,1 cm
Lifting height	61,1 cm
Width luggage compartment between wheel arches	103,8 cm
Min./Max. width tailgate opening	88,8 / 111,0 cm

* Consumption and emission trials conducted in conditions monitored by a test body approved in accordance with the World Harmonised Light Vehicle Test Procedure ("WLTP") (EURO 6d) emissions standard), a more realistic procedure for measuring the fuel consumption and CO₂ emissions of the car. The WLTP replaces the New European Driving Cycle test procedure, "NEDC", and takes account of the options and certain accessories in the car which have an impact on the weight and aerodynamics of the vehicle. In addition to fuel efficiency, driving behaviour and other non-technical factors can also result in higher fuel consumption and CO₂ emissions from the car in practice. The CO₂ emissions are displayed within a range of values with the lowest possible value and the highest possible value depending on the options and accessories chosen, that is standard equipment (the lowest) compared with full-option equipment (the highest).

ENGINE	B4
Engine code	B420T5 (K8)
Engine type	Mild hybrid petrol
Electric engine battery	Lithium-ion 48V
Battery energy capacity (nominal) kWh	0,4
Battery energy capacity (usable) kWh	-
Max. capacity petrol hp/kW/rpm	197/145/4.750-5.250
Max. capacity electric hp/kW/rpm	14/10/3.300
Max. capacity combined hp/kW	197/145
Max. torque petrol Nm/rpm	300/1.500-4.500
Max. torque electric Nm/rpm	30/2.250
Cylinders/valves/taxable horsepower	4 cylinder line/16/11
Supercharge	Turbo & 48V starter/generator
Cubic capacity (cc)	1.969
Bore & stroke (mm)	82 x 93,2
Compression ratio	12,0:1
Emissions standard	EURO 6e bis
TRANSMISSION	
Motricity	Front wheel drive
Gearbox	Automatic with double clutch 7-speed
PERFORMANCES	
Acceleration 0-100 km/h (sec)	7,6
Top speed (km/h)	180
PLUG-IN HYBRID	
On-board charger (kW)	-
Charge time 0-100% (16A/10A) 230V (hours)	-
EMISSIONS AND CONSUMPTION ACCORDING TO WLTP *	
Fuel consumption (combined) l/100 km	6,2 - 6,9
Electric power consumption (combined) kWh/100km	-
Electric range (combined) km	-
CO ₂ emissions (combined) g/km	140 - 156
WEIGHTS AND MEASURES	
Min. curb weight (kg)	1.664
Running order weight (kg)	1.734
Max. total weight (kg)	2.240
Max. braked / unbraked trailer (kg)	1.800 / 750
Max. roof load capacity (kg)	75
Largest load volume with bench seat back folded down ISO V214-1 (incl. V209) (liters)	1.431
Load compartment volume ISO V214-2 (incl. V209) (liters)	648
Load compartment volume under luggage cover ISO V211-2 (incl. V209) (liters)	519
Volume under load compartment floor (with / without spare wheel) ISO V209 (liters)	6 / 23
Fuel tank capacity (litres)	60

**SPECIFIC WARRANTY
VOLVO PLUG-IN HYBRID:**

426V batterie warranty: the batteries undergo normal wear depending on age and use. If the battery capacity falls below 65% of the original state within 5 years or 100.000 km (whichever is reached first) and below 55% between 5-8 years or 100.000-160.000 km (whichever is reached first), the battery will be replaced under guarantee.

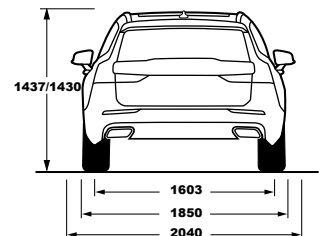
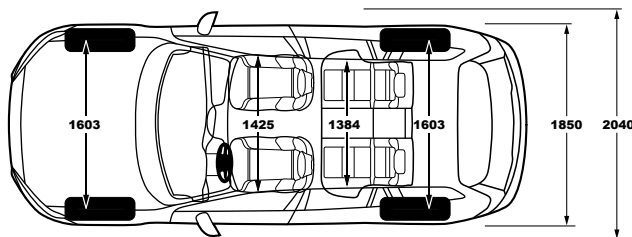
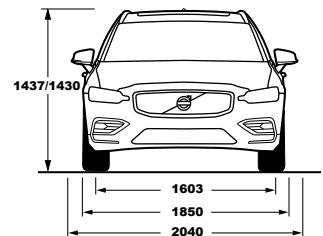
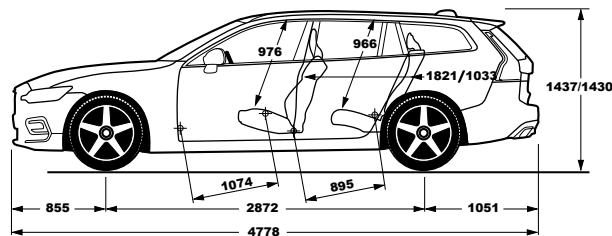

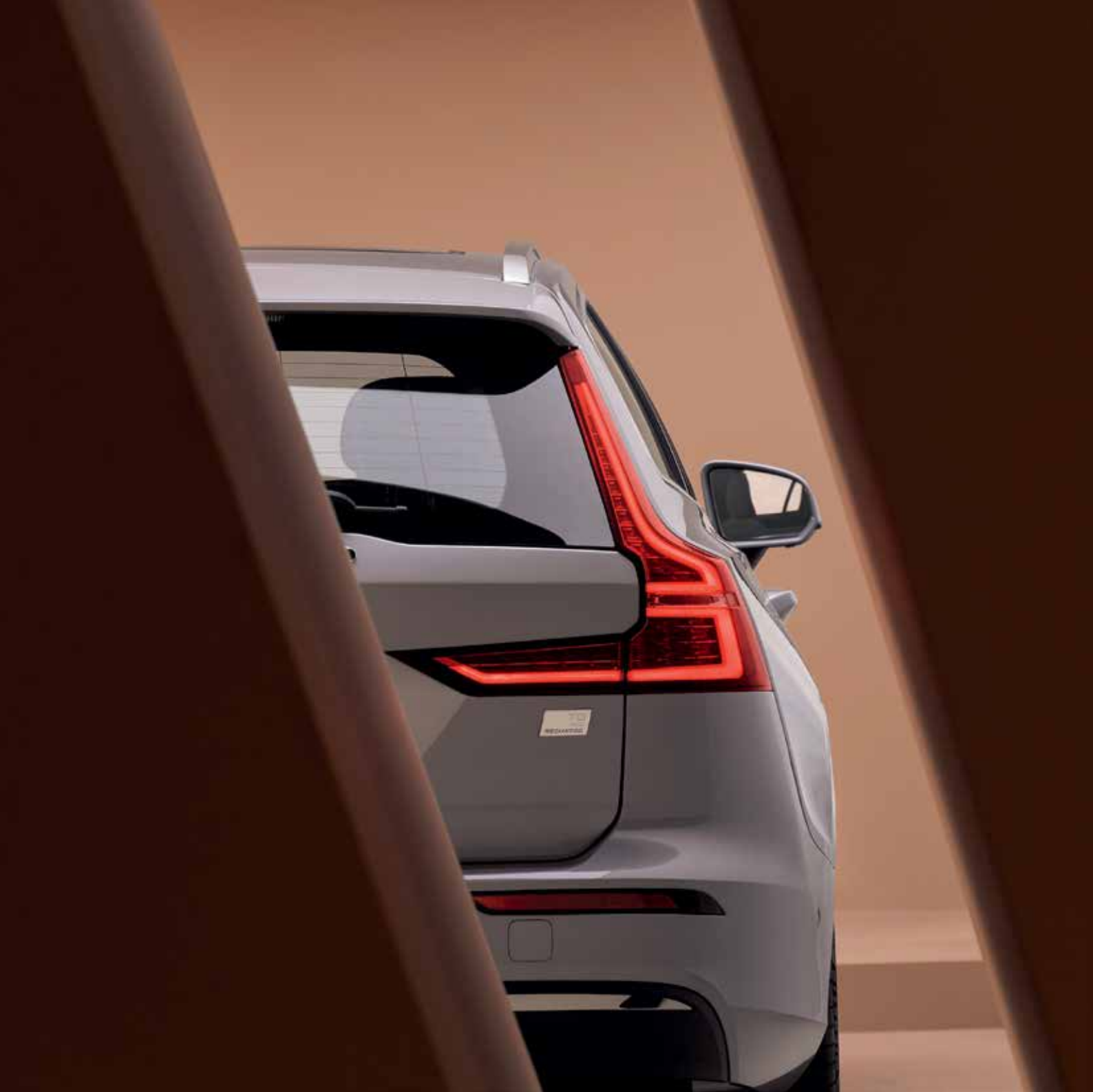

Some of the information in this brochure may be incorrect due to changes to the product specifications introduced after the brochure was published, in particular CO₂ emissions and fuel consumption figures. Volvo Car Belux reserves the right to make changes to the prices, colours, materials, specifications and models at any time without prior notice. The images shown are for information purposes only and may differ from the actual product. Certain equipment, options or accessories described or shown are available at an additional cost. All list prices in this brochure are recommended resale prices. VAT applicable is 21% for Belgium and 17% for the Grand Duchy of Luxembourg. Ask your Volvo distributor for the latest information before ordering.

The prices for accessories always include fitting (unless otherwise specified) and (where applicable) Recupel (for Belgium) or Ecotrel (for the Grand Duchy of Luxembourg). Recommended prices for wheel kits (composed of 4 complete wheels with rims and tyres) always include environmental contribution (Recytyre for Belgium), but without fitting and software update (if needed).

Environmental contribution included.

A 4-year data subscription for use of Google services and all apps is included in the retail price of the car. After that period, a paid extension of the data subscription will be available or you can share your data via your smartphone.

Environmental information [Royal Decree 19/03/2004]: all self-respecting Volvo drivers put safety first.
R.P.: Florent Andrieu - Registered address/head office: Volvo Car Belgium nv, Avenue John Kennedy 25,
B-9000 Ghent - Place of business: Volvo Car Belux - VAT no.: BE 0420.383.548

V O L V O

VOLVOCARS.BE/LU
2025 - V01.MY26

