

**V O L V O**



**V O L V O**

DIPLOMATIC  
SALES

THE NEW  
**VOLVO EX60**  
LAUNCH EDITION



p 3	Volvo EX60 offer
p 4-7	Plus standard equipment
p 8	Ultra trim level
p 10	Body paint
p 12	Wheels
p 13-15	Upholstery
p 16	Option packs
p 17	Options
p 18	Accessory packs
p 20-21	Accessories
p 22	Accessories for electric driving
p 24	Extended Services
p 25	Delivery Pack
p 26-27	Technical specifications

MADE BY  
**SWEDEN** | BUILT IN  
**SWEDEN**

## VOLVO EX60 FULLY ELECTRIC OFFER

Engines	Capacity hp/kW	Battery energy capacity nominal/usable kWh	Electric range up to km	Electric consumption kWh/100 km	Maximum power DC charging kW	List price € excl. VAT	List price € incl. VAT BE	List price € incl. VAT LU <sup>(1)</sup>
---------	-------------------	--	-------------------------------	------------------------------------	------------------------------------	---------------------------	------------------------------	---

### VOLVO EX60

#### PLUS LAUNCH EDITION

P6	374/275	83/80	611	14,9-18,0	320	<b>52.057,85</b>	62.990	60.908
P10 AWD	510/375	95/92	660	16,2-19,2	370	<b>54.537,19</b>	65.990	63.809
P12 AWD	680/500	117/112	810	16,2-19,2	370	<b>59.495,87</b>	71.990	69.610

#### ULTRA LAUNCH EDITION

P6	374/275	83/80	611	15,3-18,0	320	<b>57.760,33</b>	69.890	67.580
P10 AWD	510/375	95/92	660	16,5-19,2	370	<b>60.239,67</b>	72.890	70.480
P12 AWD	680/500	117/112	810	16,5-19,2	370	<b>65.198,35</b>	78.890	76.282

The catalogue prices above include environmental fees for the vehicle and its component streams. For Luxembourg, more info on [www.volvocars.com/lu/tarifrecyclage](http://www.volvocars.com/lu/tarifrecyclage).  
**Vehicles destined for EEA.** The models listed above are destined for the European Economic Area ('EEA') market. Volvo Cars does not guarantee the compatibility of these models with any rules or regulations applicable outside the EEA. If you export these models outside of the EEA or if you request us to do so for you, such export will take place at your own risk.

**Export of vehicles.** Export outside of the country of purchase in any event occurs at your risk and cost. The prices listed above are exclusive of freight charges, taxes, licenses and any other documentation related to the export of your vehicle outside of the country of purchase. In case of export, the dealer will request you to deposit the amount of VAT applicable in the country of purchase as a guarantee. The dealer will reimburse the relevant amount to you upon receipt of (i) proof that you are exempted from VAT in the country where the vehicle is registered, or (ii) proof that VAT has been paid in the country where the vehicle is registered.

**(1) Prices.** A delivery fee of € 250 (excl. VAT) will be added to the prices listed above for vehicles supplied in the Grand Duchy of Luxembourg. The above-listed prices are furthermore exclusive of dealer preparation fees. Therefore, additional charges may be applied at your delivery point. Finally, you will be responsible for the payment of VAT (as applicable in the country of first registration of your vehicle) and any other taxes, as well as any registration and similar fees, all to the extent applicable. For ease of reference, VAT as currently applicable in Belgium and the Grand Duchy of Luxembourg are listed above.

LAUNCH EDITION PACK*	List price € excl. VAT	List price € incl. VAT BE	List price € incl. VAT LU
-   Metallic colour of your choice to replace Ice White	818,18	990	957
179   Privacy glass for rear windows	404,96	490	474
<b>PB108   LAUNCH EDITION PACK</b>	<b>1.223,14</b>	<b>1.480</b>	<b>1.431</b>

\*Launch Edition Pack temporarily mandatory from 01/04/2026 until the 30/06/2026 - Request a tailor-made quote from your local retailer.



## STANDARD EQUIPMENT PLUS

PLUS	List price € excl. VAT	List price € incl. VAT BE	List price € incl. VAT LU	P6	P10 AWD	P12 AWD
Volvo EX60 Plus standard equipment	0,00	0	0	S	S	S

S = Standard

### SAFETY

Extensive sensor set: system consisting of a 360° safety screen around the car to anticipate hazards and prevent collisions.

It consists of:

- 5 radars
- 5 cameras
- 12 ultrasonic sensors

Stability and traction control: Electronic Stability Control (ESC) including Active Yaw Control, Advanced Stability Control, Trailer Stability Assist (only with the tow bar) and Hill Descent Control | Traction Control (TC) including Corner Traction Control with Torque Vectoring | Spin Control

Driver understanding system: 2 cameras detecting when the driver's attention is no longer focused on the road. It alerts the driver or intervenes by braking and steering for a safe outcome when needed. If the driver is no longer responsive due to sudden sickness or unconsciousness, the car can automatically brake to standstill within the lane and activate the hazard lights

Occupant sensing system: roof-mounted interior camera and radars helping the driver to avoid leaving in the cabin loved ones behind in potential danger. The car will alert you if it looks like you're accidentally locking a sleeping child or snoring dog in the car, while the in-car climate system (if enough battery) can also potentially help minimize the risk of hypothermia and heatstroke

Front multi-adaptive seat belts. This technology is a world first and uses real-time data from advanced interior and exterior sensors to adjust the restraining force according to the occupant and the situation

Height-adjustable seat belts in front and with pre-tensioners and load limiters front and rear

Connected Safety technology including Slippery Road Alert and Hazard Light Alert

Automatic braking after a collision

Tyre Pressure Monitoring System (TPMS)

Ultra-resistant structure of vehicle interior and roof in boron steel

Collapsible steering column

Automatic unlocking after a collision

The 800V battery acts as a structural member in a side collision to help protect the battery itself as well as helping to reduce the risk of intrusion into the passenger compartment

Front airbags and SIPS® side airbags

Far side airbags inside of the front seats between the occupant and the central console

Inflatable curtains airbags covering both seat rows

Knee airbag for the driver

WHIPS® (Whiplash Injury Protection System): provides protection against injuries due to whiplash thanks to specific energy-absorbing backrests and seats and head restraints integrated into the front seats

Emergency brake lights

Isofix anchorages for the outer positions of the rear seat

Interior radar to detect if there is a person sitting in any of the seats (instead of a small bag for example), used for the belt reminder system

Front passenger airbag cut-off switch

Power-operated child safety lock on rear doors

Acoustic Vehicle Alerting System (AVAS) at slow speed

### DRIVER ASSISTANCE

Rear Park Assist Camera

Front, rear and side Park Assist

Adaptive Cruise Control

Advanced safety alert and intervention system, including:

- Blind Spot Information System with steering assistance (BLIS)
- Door opening alert when cars, pedestrians, cyclists scooters or motorcycles approach from behind
- Rear Collision Warning and Mitigation with rear hazard warning lights activation, and automatic emergency braking if the car is at a standstill
- Rear Cross Traffic Alert: detection of vehicles coming from the side when reversing

Intersection Autobrake function that can intervene if there is a risk of collision. When the driver is about to make a left turn in an intersection with oncoming traffic, the car can brake automatically to help avoid an impact. This function can also support in straight crossings with traffic coming from the sides

Lane Keeping Aid: helps the driver to stay in lane, including Run-off Road Mitigation: helps prevent the vehicle from running off the road, with steering aid and braking intervention (active between 60 and 140 km/h)

Oncoming Lane Mitigation: helps the driver to avoid collisions with vehicles coming in the opposite direction by automatically adjusting the steering (active between 50 and 140 km/h)

Oncoming Mitigation by Braking: automatic braking system attenuating the impact of a head-on collision

Vehicle, Cyclist, Pedestrian and Large Animals Detection: thanks to the sensing technology, the car can detect moving as well as stationary cars, trucks and buses, but also motorcycles, scooters, pedestrians, cyclists and large animals

Pedestrian, Cyclist and Scooter Steering Avoidance: on a rural road without pavement and with clearly visible road marks, when you catch up a cyclist, pedestrian or a scooter travelling in the same direction as you but haven't spotted it immediately, this new function can help you avoid a collision. If the car senses a collision is likely to happen, it can actively take over the steering and steer away as long as you don't cross the lane markings. After having passed the road user with a sufficient safety distance, the car regains its position on the road

Pedestrian and cyclist protection: designed to minimize the impact of a collision with a pedestrian. The hood is raised and moves towards the windshield to absorb the impact of the pedestrian while protecting the windshield

Intelligent Speed Assist (ISA)

Road Sign Information (RSI): display of road sign information

Ready to Drive notification: function that informs the driver via a sound and a visual notification if the vehicle is still standing still even though the vehicle in front has moved a certain distance or exceeded a certain speed

---

## STANDARD EQUIPMENT PLUS

---

---

### MULTIMEDIA & CONNECTIVITY

11,4" forward driver display positioned closer to the windscreen, directly in the driver's line of sight, for optimal visibility. This allows the driver to access valuable information while staying focused on the road. Choice between 3 display modes: Calm, Surround, and Map

15,04" OLED center display touchscreen with 2640x1416 pixels resolution and gentle curvature. In a landscape format

Bose Premium audio system with 21 speakers incl. a subwoofer, front headrests subwoofers and 24-channel 1.200 watts amplifier

Google infotainment system with:

- Google Maps: navigation and public charging stations locator
- Google Assistant: voice assistant via "Hey Google" to control certain car functions, navigation, your smartphone, media, search for online information or control certain connected devices
- Google Play Store: access to a catalog of in-car apps to download and use in the car (such as Spotify®, Waze®, Amazon Prime Video® and YouTube®)

4-year data subscription for use of Google services and all apps. After that period, a paid extension of the data subscription will be available or you can share your data via your smartphone

Remote functions via the Volvo Cars app on your smartphone, such as:

- launch and plan the preconditioning to cool/heat the cabin to comfort temperature and optimize your battery before departure
- (un)lock your car
- localize your car
- access to the Driving Journal
- plan and check the status of your electric charging session

Wireless charging for smartphone (15W) (electromagnetic induction technology) in the shelf over the glove box

4 USB-C connections: 2 connections with 60 W and 2 with 18 W

Wireless smartphone integration (Apple CarPlay®) | Access to third developers apps such as Waze, Spotify® and WhatsApp®

5G capabilities

OTA: Over The Air updates for the car

DAB+ (Digital Audio Broadcasting)

Bluetooth® hands-free telephone system and audio streaming

Controls integrated into the steering wheel for driver display, cruise control, audio, telephone, navigation system and voice commands

Integrated "SOS" button for assistance in life-threatening emergencies

Integrated "On Call" button for roadside assistance

Volvo Assistance | 3 years subscription included

---



---

## STANDARD EQUIPMENT PLUS

---

---

### PERSONAL SAFETY AND CONVENIENCE

---

Volvo Guard alarm with movement sensor, inclination sensor

Digital Key Plus:

- open, close and start your car via the Volvo Car app from a compatible iPhone (from iPhone 11). Samsung and Google smartphone compatibility to be added later on.
- share of this digital key to your friends by sending an invitation via the Volvo Cars app
- within 10 meters the car 'wakes up' with a welcome light sequence
- within 1,5 meters the car unlocks, the exterior mirrors unfold, the interior light is activated, the central display shows the charging state and the cable unlocks for 90 seconds

Key card: open, close and start your car via 2 provided NFC cards

Keyless Entry:

- passive (un)locking and hands-free opening/closing of tailgate (foot movement under the rear bumper)
- welcome and farewell sequence playing an illuminated signature in front and rear of the car
- entry light and ground light

Power-operated tailgate

Power operated steering column

Electric parking brake with Auto Hold (automatic brake at a standstill) and Hill Start Assist (assistance to start on a hill or slope) functions

Drive Modes: up to 4 modes making it easy to adapt both vehicle behaviour and powertrain characteristics to personal preferences

- Standard: it gives a good balance between performance, drivability, comfort and low energy consumption
- Range: it prioritise low energy consumption to maximise the car's range
- Offroad: available below 40 km/h, it activates Hill Descent Control that helps maintain a comfortable speed at steep, rough and slippery roads. It facilitates also towing of a heavy trailer
- Performance (P10/P12 AWD): it makes the car constant 50/50 all-wheel drive while making it feel sportier and more agile with quicker response

Tyre repair kit in the front load compartment under the hood

### CLIMATE CONTROL

---

Heated front seats

Three-zone electronic automatic climate control system

Preconditioning to cool/heat the cabin to comfort temperature, via Volvo Cars app

AQS (Interior Air Quality System) to improve air quality inside the vehicle, with active filter

Air purifier and remote cabin pre-cleaning with:

- an advanced pre-filter and multi-filter that remove up to 99% of all harmful PM2.5 particles from the air inside the cabin
- an internal and external PM2.5 sensor allowing the concentration of these harmful particles inside and outside the cabin to be compared via the central display
- the ability, via the Volvo Cars app, to reduce the concentration of harmful PM2.5 particles and other unwanted substances to a minimum

Heat in grilleblem for the hidden radar

Rain sensor with adjustable sensitivity level

### VERSATILITY

---

Frunk (58 l) under the hood

Removable rear storage box underneath the back of the armrest

Map storage pocket behind the front seats

Large 63-litre dual-zone luggage compartment underfloor storage (40/60): makes it easy to separate, for example, dirty and clean items. Each compartment is designed to hold storage accessories specific to the EX60

Load compartment control panel in the luggage compartment with buttons to fold out optional electrical towbar with just one touch

Nylon safety net between the back of the 1st or 2nd row and the luggage compartment

Luggage cover that can be stored beneath the luggage compartment floor

Four folding load retainer eyelets and grocery bag holders in luggage compartment

12V power outlet in the luggage compartment

### INTERIOR

---

Upholstery made from biosourced Charcoal Nordico

Tailored asymmetrical dashboard inspired by Scandinavian design with integrated soundbar

Power-operated front seats with memory function for the driver (length, height, tilt, recline)

Power-operated two-way lumbar support in front seats with memory function for the driver

Front seats with seat cushion extension

Second-row seats manually foldable in three sections (40/20/40), with electric folding of the rear seats in two sections via a button in the luggage compartment

Electrically operated rear outer backrests (inclination adjustable between 25° and 33°)

Power folding of the rear headrests

Rear armrest with 2 cupholders under a folding lid. When the lid is open, two smartphones can be leaned against it for easy access

Flat rear floor

Frameless interior rear-view mirror with automatic autodim function

Central console with:

- armrest between the front seats
- sliding unit between the front seats that serves as a cupholder as well as storage box for a smartphone
- open storage area on the floor
- storage for up to two phones above the central glove box
- centrally positioned glove box for smaller items beneath the centre display including a small removable storage

Standard interior lighting including:

- interior and reading lights in the roof, front and rear
- footwell lighting, front and rear
- door pocket lights, front and rear
- door panel ambience lights, front and rear
- lighting behind the centre display
- center console lighting
- wireless phone charger storage illumination
- illuminated vanity mirrors
- sliding cupholder lighting
- functional light in centre glovebox
- powerful boot lighting in the luggage compartment roof

Six ambient light themes, front and rear

---

---

## STANDARD EQUIPMENT PLUS

---

---

### EXTERIOR

---

Flush, clean and pure design for optimal performance and range:

- closed front end grill
- frameless exterior mirrors
- frameless doors
- flush glazing i.e. side windows, b-pillar, c-pillar are all in the same surface
- wing grip door handles

Black elements:

- trim on side windows
- exterior side mirrors
- lower front and rear bumpers
- lower door mouldings
- rear spoiler

Matt silver bright elements:

- decors in the lower door sills
- decors in the lower part of the front and rear bumpers

Fixed panoramic sunroof with dark tinted laminated glass and IR coating that minimises glare and gives effective UV protection

20" alloy wheels

Daytime running lights with Thors-Hammer segmented design that, together with the rear LED lamps, create welcome or farewell light sequences

Matrix-design LED headlights with 15 segments and placed under the daytime running lights with:

- Active High Beam: allows the driver to stay on high beam all the time. Using the front camera, the car can adjust the light image to optimise it
- light pattern that will adapt automatically to not dazzle other road users when the car is heavily loaded

Rear LED light with welcome and farewell sequence playing an illuminated signature

Frameless power retractable and heated exterior mirrors, with memory function, integrated indicator and, on driver's side, automatic dimming

Dynamic chassis for a comfort and premium driving experience (P6)

Active chassis with FOUR-C: advanced electronically-controlled shock absorption system providing exceptional driving comfort, handling and road holding, and maximum stability when towing, constantly adapting to the conditions (P10/P12 AWD)

EX60 and engine emblem at the rear

AWD emblem at the rear (P10/P12 AWD)

### FULLY ELECTRIC

---

Heat pump

22 kW onboard charger (AC-DC converter)

320 kW max DC charging (P6)

370 kW max DC charging (P10/P12 AWD)

32 A charging cable, Mode 3, with Mennekes socket (22kW, for charging point), 6 metres

One Pedal Drive: possibility to use only one pedal to accelerate or brake. Just by lifting the pedal the driver can, on a short distance, slow the car all the way to standstill not having to use the brake pedal

Battery Passport: digital document, accessible via QR code, with information about the battery

---











## TRIM LEVEL

ULTRA	List price € excl. VAT	List price € incl. VAT BE	List price € incl. VAT LU	P6	P10 AWD	P12 AWD
(Includes the EX60 Plus equipment supplemented by the specific Ultra equipment)	<b>5.702,48</b>	6.900	6.672	O	O	O
*Supplement already included in the prices per trim level as shown on page 3. <span style="float: right;">O = Option</span>						
21" alloy wheels						
Bowers & Wilkins High Fidelity audio system with immersive 3D sound experience thanks to Dolby Atmos surround sound:						
<ul style="list-style-type: none"> <li>- 28 speakers strategically placed throughout the interior: 5 tweeters, 6 mid-range speakers, 4 woofers, 8 twiddlers in the headrests, 1 ventilated subwoofer</li> <li>- 28-channel amplifier with a total output of 1.820 watts</li> <li>- special sound modes for unique acoustic experiences</li> </ul>						
Crystal volume knob						
Electrochromic glass for the panoramic roof: adjustable roof opacity. Allows you to quickly switch from clear to opaque using an electric tension system						
Laminated side windows:						
<ul style="list-style-type: none"> <li>- help to reduce noise from the outside so that you and your passengers can enjoy an even quieter ride</li> <li>- enhance your security as the windows' high resistance to external force makes it hard for a thief to break into your car</li> <li>- for your comfort, contribute to reduce UV radiation inside the cabin</li> </ul>						
Ventilated front seats with power-operated four-way lumbar support (two-way with W3A0 optional upholstery)						
High Definition Pixel headlights, featuring:						
<ul style="list-style-type: none"> <li>- module with 25,600 pixels offering countless possibilities to adapt the light image to prevailing conditions</li> <li>- Active High Beam that allows continuous use of high beams. The light image is adjusted to optimize light without dazzling other road users (up to 5 cars and 3 other objects can be auto dimmed at the same time)</li> <li>- Cornering Light for optimal illumination throughout the curve, thanks to the light beam that follows the steering wheel movements</li> <li>- Bending Light</li> </ul>						
Specific light animation serving as a welcome and farewell sequence, via the daytime running lights, LED headlights and rear lights. At the same time, an animation can be projected onto a wall						
High-pressure headlight washers						
360° Park Assist Camera with 3D view:						
<ul style="list-style-type: none"> <li>- 1 front 180° camera up to 16 km/h</li> <li>- 1 rear camera with trajectory lines</li> <li>- 2 lateral cameras in the door mirrors</li> <li>- 360° bird-view in 3D via the 4 cameras up to 16 km/h</li> </ul>						
Ultra emblem on the tailgate						





## BODY PAINT

			List price € excl. VAT	List price € incl. VAT BE	List price € incl. VAT LU	EX60
614	Ice White (non metallic)		0,00	0	0	●
707	Crystal White Pearl		818,18	990	957	○
717	Onyx Black					
723	Denim Blue					
740	Vapour Grey					
743	Sand Dune					
745	Aurora Silver					
746	Forest Lake					
750*	Heather Bronze					

\*Production with this paint will start in week 51 of 2026.

○ = Option | ● = Included in trim level







## DARK PACK

	List price € excl. VAT	List price € incl. VAT BE	List price € incl. VAT LU	EX60
<b>1338 DARK PACK</b>				
Add a sportive touch to the exterior of your EX60 with high gloss black inserts in:	<b>239,67</b>	290	280	O
- the lower door trims				
- the front bumper				
- the rear bumper				

O = Option



## WHEELS

		List price € excl. VAT	List price € incl. VAT BE	List price € incl. VAT LU	PLUS	ULTRA
<b>20" ALLOY WHEELS</b>						
	- 20" 5-spoke matt/glossy black diamond cut with aero inserts 235/55 R20 Front tyres, 255/50 R20 Rear tyres	0,00	0	0	●	-
<b>21" ALLOY WHEELS</b>						
	1296 21" 5-spoke glossy black/matt graphite diamond cut with aero inserts 255/45 R21 Front tyres, 265/45 R21 Rear tyres	818,18 0,00	990 0	957 0	0 -	- ●
	1304 21" 6-spoke matt/glossy black diamond cut with aero inserts 255/45 R21 Front tyres, 265/45 R21 Rear tyres	983,47 165,29	1.190 200	1.151 193	0 -	- 0
<b>22" ALLOY WHEELS</b>						
	1297 22" 5-Y-spoke matt black diamond cut 255/40 R22 Front tyres, 265/40 R22 Rear tyres	1.636,36 818,18	1.980 990	1.915 957	0 -	- 0
	1345 22" 5-Y-spoke matt black 255/40 R22 Front tyres, 265/40 R22 Rear tyres	1.801,65 983,47	2.180 1.190	2.108 1.151	0 -	- 0
<b>ALL-SEASON TYRES</b>						
	1065 All-season tyres 20" replacing the standard tyres, exclusively available in combination with 20" rims	322,31	390	377	0	-

O = Option | ● = Included in trim level | - = Not available

## UPHOLSTERY PLUS AND ULTRA

	List price € excl. VAT	List price € incl. VAT BE	List price € incl. VAT LU	PLUS	ULTRA
<b>BIO-SOURCED NORDICO</b>					
COMFORT SEATS (xDx0)	0,00	0	0	●	–
VENTILATED FRONT COMFORT SEATS (xGx0)	818,18	990	957	○	●
<b>Charcoal (RD00/RG00)</b>	Colour interior base: Charcoal Colour seats: Charcoal Colour headlining: Charcoal Inlays dashboard: weathered grey ash wood				
<b>Cardamom (RD10/RG10)</b>	Colour interior base: Charcoal Colour seats: Cardamom Colour headlining: Charcoal Inlays dashboard: weathered grey ash wood				
<b>Dawn (WD20/WG20)</b>	Colour interior base: Dawn Colour seats: Dawn Colour headlining: Dawn Dual-tone steering wheel: Dawn/Charcoal Inlays dashboard: weathered grey ash wood Mats and floor: dark rubus				

○ = Option | ● = Included in trim level | – = Not available



## UPHOLSTERY PLUS AND ULTRA

		List price € excl. VAT	List price € incl. VAT BE	List price € incl. VAT LU	PLUS	ULTRA
<b>NAPPA LEATHER</b>						
<b>VENTILATED FRONT COMFORT SEATS</b>		2.057,85	2.490	2.408	0	-
		1.239,67	1.500	1.450	-	0
<b>Charcoal (RC00)</b>	Colour interior base: Charcoal Colour seats: Charcoal Colour headlining: Charcoal Inlays dashboard: weathered grey ash wood					
<b>Cardamom (RC10)</b>	Colour interior base: Charcoal Colour seats: Cardamom Colour headlining: Charcoal Inlays dashboard: weathered grey ash wood					
<b>Dawn (WC20)</b>	Colour interior base: Dawn Colour seats: Dawn Colour headlining: Dawn Dual-tone steering wheel: Dawn/Charcoal Inlays dashboard: dark rubus fused ash wood Mats and floor: dark rubus					

O = Option | - = Not available



## UPHOLSTERY ULTRA

		List price € excl. VAT	List price € incl. VAT BE	List price € incl. VAT LU	PLUS	ULTRA
<b>ANIMAL WELFARE TAILORED WOOL BLEND</b>						
Rye (W3A0)	Colour interior base: Dawn	818,18	990	957	0	-
	Colour seats: Rye	0,00	0	0	-	0
	Colour headlining: Dawn					
	Dual-tone steering wheel: Dawn/Charcoal					
	Inlays dashboard: dark rubus fused ash wood					
	Mats and floor: dark rubus					

O = Option | - = Not available



## OPTION PACKS

	List price € excl. VAT	List price € incl. VAT BE	List price € incl. VAT LU	PLUS	ULTRA
<b>CRUISE PACK</b>					
139   360° Park Assist Camera with 3D view (standard on Ultra)	570,25	690	667		
1083   Park Pilot Assist (intelligent parking assistant): - detect free parking lots on both spaces of the street up to 30 km/h - automatic parking by taking over the steering as well as the accelerator, brakes and gear shifts - works for parallel, fishbone and perpendicular parking - support when leaving a tight parallel parking space	818,18	990	957		
1162   Pilot Assist: keep an eye on the traffic and lane markings, supports you by adapting the speed and providing gentle steer assist to keep the car centered in its lane with maintained distance to the vehicle in front. Active from standstill up to 150 km/h	735,54	890	861		
<b>Total value of equipment</b>	<b>2.123,97</b>	2.570	2.485		
<b>Diplo Pack advantage</b>	<b>-479,34</b>	-580	-561		
P0012   <b>CRUISE PACK</b>	<b>1.644,63</b>	1.990	1.924	0	-
<b>Total value of equipment</b>	<b>1.553,72</b>	1.880	1.818		
<b>Diplo Pack advantage</b>	<b>-322,31</b>	-390	-377		
P0012   <b>CRUISE PACK</b>	<b>1.231,40</b>	1.490	1.441	-	0
<b>WINTER PACK</b>					
63   Heated windsreen washer nozzles	74,38	90	87		
752   Heated rear seats (outer seating positions 2nd row)	322,31	390	377		
869   Heated steering wheel	239,67	290	280		
<b>Total value of equipment</b>	<b>636,36</b>	770	745		
<b>Diplo Pack advantage</b>	<b>-231,40</b>	-280	-271		
P0008   <b>WINTER PACK</b>	<b>404,96</b>	490	474	0	0

O = Option | - = Not available



## OPTIONS

		List price € excl. VAT	List price € incl. VAT BE	List price € incl. VAT LU	PLUS	ULTRA
<b>DRIVER ASSISTANCE</b>						
139	360° Park Assist Camera with 3D view	570,25	690	667	0	●
<b>SAFETY &amp; PROTECTION</b>						
236	Laminated side windows: - help to reduce noise from the outside so that you and your passengers can enjoy an even quieter ride - enhance your security as the windows' high resistance to external force makes it hard for a thief to break into your car - for your comfort, contribute to reduce UV radiation inside the cabin	570,25	690	667	0	●
322*	Child booster cushions in the outer rear seats: ensure your child is in the correct position for the seatbelt. They provide both comfort and better visibility for your child. When not in use, they can be neatly folded into the seat	322,31	390	377	0	0
<b>EXTERIOR</b>						
179	Privacy glass for rear windows	404,96	490	474	0	0
<b>INTERIOR</b>						
1291	Electrochromic glass for the panoramic roof: switchable transparency of the glass	818,18	990	957	0	●
<b>VERSATILITY</b>						
1028	Automatic retractable tow bar with 13-pin outlet (Trailer Stability Assist system included)	983,47	1.190	1.151	0	0

\*Not with Wolmix interior (W3A0)

0 = Option | ● = Included in trim level



## ACCESSORY PACKS

	List price € excl. VAT	List price € incl. VAT BE	List price € incl. VAT LU	EX60
<b>PROTECTION PACK</b>				
A00492   All-weather interior cabin floor mats	119,83	145	140	
A00112   All-weather load compartment mat	128,10	155	150	
A00217   Lockable wheel bolt/nuts kit	57,85	70	68	
A01865   All-weather frunk mat	33,06	40	39	
A01881   All-weather underfloor mat	33,06	40	39	
<b>Total value of equipment</b>	<b>371,90</b>	450	435	
<b>Diplo Pack advantage</b>	<b>-82,64</b>	-100	-97	
<b>PA001   PROTECTION PACK</b>	<b>289,26</b>	<b>350</b>	<b>338</b>	<b>O</b>

<b>CONVENIENCE PACK</b>				
A01247   Charging cable storage bag	57,85	70	68	
A01435   Neck pillow	78,51	95	92	
A01437   Sunshade for panoramic roof	119,83	145	140	
A00106   Cargo net for the trunk	57,85	70	68	
<b>Total value of equipment</b>	<b>314,05</b>	380	367	
<b>Diplo Pack advantage</b>	<b>-86,77</b>	-105	-102	
<b>PA003   CONVENIENCE PACK</b>	<b>227,27</b>	<b>275</b>	<b>266</b>	<b>O</b>

<b>TRAVEL PACK</b>				
A01399   Roof box, Travel Premier 430	962,81	1.165	1.126	
A01882   Black transversal splittable roof bars	454,55	550	532	
<b>Total value of equipment</b>	<b>1.417,36</b>	1.715	1.658	
<b>Diplo Pack advantage</b>	<b>-202,48</b>	-245	-237	
<b>PA105   TRAVEL PACK</b>	<b>1.214,88</b>	<b>1.470</b>	<b>1.421</b>	<b>O</b>

<b>TRAVEL PACK LARGE</b>				
A01241   Roof box, Travel Active 500	756,20	915	885	
A01647   Cargo Bag	78,51	95	92	
A01874   Underfloor bag, large	99,17	120	116	
A01882   Black transversal splittable roof bars	454,55	550	532	
<b>Total value of equipment</b>	<b>1.388,43</b>	1.680	1.624	
<b>Diplo Pack advantage</b>	<b>-198,35</b>	-240	-232	
<b>PA103   TRAVEL PACK LARGE</b>	<b>1.190,08</b>	<b>1.440</b>	<b>1.392</b>	<b>O</b>

O = Option



## ACCESSORY PACKS

	List price € excl. VAT	List price € incl. VAT BE	List price € incl. VAT LU	EX60
<b>KIDS PACK</b>				
A00096   Kids Guard	66,12	80	77	
A01507   Volvo rear-facing child seat	516,53	625	604	
<b>Total value of equipment</b>	<b>582,64</b>	<b>705</b>	<b>682</b>	
<b>Diplo Pack advantage</b>	<b>-61,99</b>	<b>-75</b>	<b>-73</b>	
PA005   <b>KIDS PACK</b>	<b>520,65</b>	<b>630</b>	<b>609</b>	0

<b>STORAGE PACK</b>				
A01873   Underfloor bucket	33,06	40	39	
A01883   Underfloor bag, medium	82,64	100	97	
<b>Total value of equipment</b>	<b>115,70</b>	<b>140</b>	<b>135</b>	
<b>Diplo Pack advantage</b>	<b>-24,79</b>	<b>-30</b>	<b>-29</b>	
PA107   <b>STORAGE PACK</b>	<b>90,91</b>	<b>110</b>	<b>106</b>	0

O = Option



## ACCESSORIES

		List price € excl. VAT	List price € incl. VAT BE	List price € incl. VAT LU	EX60
<b>LUGGAGE COMPARTMENT AND FRUNK</b>					
A00112	Moulded plastic load compartment protection	128,10	155	150	0
A00119	Textile/plastic reversible load compartment floor mat	181,82	220	213	0
A00106	Luggage net to be attached to load securing eyelets	57,85	70	68	0
A00067	Load cover	190,08	230	222	0
A00189	Steel protective grille between the load compartment and the rear seat	252,07	305	295	0
A01873	Underfloor bucket	33,06	40	39	0
A01883	Medium underfloor bag	82,64	100	97	0
A01874	Large underfloor bag	99,17	120	116	0
A01881	All-weather underfloor mat	33,06	40	39	0
A01865	All-weather frunk mat	33,06	40	39	0
<b>ADVENTURE</b>					
A00463*	Preparation for mounting tow bar as accessory	0,00	0	0	0
	Automatic retractable tow bar with 13-pin outlet (Trailer Stability Assist system included)	983,47	1.190	1.151	0
A01647	Cargo Bag	78,51	95	92	0
A01238	Folding bicycle holder on tow bar for two bicycles (Fix4Bike)	685,95	830	803	0
A01239	Bicycle holder on tow bar for three bicycles (Fix4Bike)	710,74	860	832	0
A01882	Black transversal splittable roof bars	454,55	550	532	0
A01240	Roofbox 'Travel 400', glossy black (400L, 175x87x46 cm)	665,29	805	778	0
A01241	Roofbox 'Travel Active 500', glossy black (500L, 215x92x44 cm)	756,20	915	885	0
A01399	Roofbox 'Travel Premier 430', glossy black (430L, 223x94x30 cm), with LED lighting	962,81	1.165	1.126	0
A00220	Retractable ski holder, to mount on roof bars	185,95	225	218	0
A00025	Bicycle holder with frame bracket (aluminium), to be fitted on load carrier (1 bicycle)	128,10	155	150	0
A01637	Lock kit - one key system	61,98	75	73	0
A01601	Roof tent	2.272,73	2.750	2.659	0
A01595	Tow Cargo box (+holder)	1.157,02	1.400	1.354	0
A01594	Roof basket	454,55	550	532	0
A01624	Roof basket extender	165,29	200	193	0
A01593	Kayak holder	371,90	450	435	0

\* Accessories that affect the weight and aerodynamics of the car, and therefore also the electricity consumption and the range measured according to the WLTP. O = Option



## ACCESSORIES

		List price € excl. VAT	List price € incl. VAT BE	List price € incl. VAT LU	EX60
<b>DESIGN</b>					
A00458	Integrated running boards in brushed stainless steel	1.239,67	1.500	1.450	0
<b>COMFORT</b>					
A00492	All-weather interior cabin floor mats	119,83	145	140	0
A01437	Sunshade for panoramic roof	119,83	145	140	0
A01244	Comfort pillow	57,85	70	68	0
A01435	Neck pillow	78,51	95	92	0
A01839	Rear comfort pillow	57,85	70	68	0
<b>CHILD SAFETY</b>					
A01507	Volvo rear-facing child seat	516,53	625	604	0
A01591	Seat booster	330,58	400	387	0
A00096	Kick guard with storage pockets	66,12	80	77	0
<b>SECURITY &amp; PROTECTION</b>					
A01251	Key Tag	181,82	220	213	0
A00604	Dog harness	119,83	145	140	0
A00217	Anti-theft wheel locks	57,85	70	68	0
A00164*	Front mud flaps	78,51	95	92	0
A00165*	Rear mud flaps	78,51	95	92	0
A00228	AutoSock (snow socks)	107,44	130	126	0
A00227	Centrax snow chains (for 20" wheels)	404,96	490	474	0
A01327	Digital rearview mirror	739,67	895	865	0

\* Accessories that affect the weight and aerodynamics of the car, and therefore also the electricity consumption and the range measured according to the WLTP. O = Option



## ACCESSORIES FOR ELECTRIC DRIVING



Discover our range of accessories specially designed for electric vehicles. Offering both performance, comfort, and style, these products are perfect for enhancing your driving experience. Explore innovative solutions that adapt to your needs and optimize your vehicle's range and practicality.

## VOLVO WALLBOX AND ACCESSORIES

We are excited to introduce our brand-new charging station, now available to support your electric journeys. Designed for fast and convenient charging, it's the perfect accessory to ensure a seamless experience at home. Take advantage of this innovative solution, easy to install, so you're always ready to hit the road.



	List price € excl. VAT	List price € incl. VAT BE	List price € incl. VAT LU	EX60
<b>VOLVO WALLBOX</b>				
A01815* Wallbox without cable, installation included	<b>1,818,18</b>	2,200	2,127	O
A01814* Volvo wallbox with integrated cable, installation included	<b>1,900,83</b>	2,300	2,224	O
A01816* Wallbox without cable + certification MID, installation included	<b>2,024,79</b>	2,450	2,369	O
A01627 RTM or Load balancer	<b>140,50</b>	170	164	O

\* Indicative price for a charging station with one fixed 7 m cable (A01814) or socket (A01815) and with MID (A01816). The indicated price includes a standard installation, which also covers a remote check of the installation by phone, wall or pole mounting (with groundworks up to a maximum of 1 m), a residual current device, fuses, a 12 m power cable, a 12 m data cable, a 12 m conduit, explanations, delivery of a single-line diagram, and a legal inspection. This installation does not include demolition or excavation work. The final price will be provided through a tailored quote based on a phone consultation or an on-site visit if necessary.

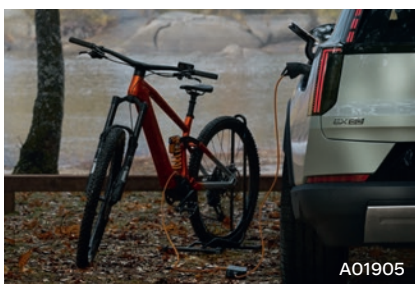

	List price € excl. VAT	List price € incl. VAT BE	List price € incl. VAT LU	EX60
<b>ADDITIONAL ACCESSORIES</b>				
A01247 Charging cable storage bag	<b>57,85</b>	70	68	O
A01905 Vehicle to load adapter (V2L)	<b>165,29</b>	200	193	O
A01895 Charging cord 1P 10A with Schuko socket (for domestic use), length 7 metres	<b>363,64</b>	440	425	O
A01899 Charging cord 1P 16A with CEE socket (for blue industrial socket, 3 pins), length 7 metres	<b>363,64</b>	440	425	O
A01355 Charging cord 3P 16A mode 3 (type 2) with Mennekes socket (for charging point), length 6 metres	<b>363,64</b>	440	425	O
A01154 Charging cord 1P 16A mode 3 (type 2) with Mennekes socket (for charging point), length 7 metres	<b>363,64</b>	440	425	O

O = Option



## EXTENDED SERVICES

### VOLVO CAR EXTENDED WARRANTY

Drive with **peace of mind**

When you buy a Volvo, you are choosing top quality, safety and reliability. Not only because you are buying a quality vehicle, but also because your Volvo dealer offers you the best service.

An extension of the factory guarantee protects you against high costs in the event of unexpected defects. Thanks to the very comprehensive coverage, you can drive your Volvo for an additional 2 years without any worries when your Volvo manufacturer's warranty expires after 3 years.

Volvo Car Extended Warranty protects you against unforeseen repair costs, even after the Volvo manufacturer's warranty has expired.

#### GUARANTEED LIQUIDITY IN CASE OF REPAIRS

And extensive repair costs reimbursement outside the manufacturer's warranty

#### VALID ANYWHERE IN EUROPE

The extended warranty can also be transferred to the next owner

#### USE OF GENUINE VOLVO PARTS

And repaired by Volvo-trained personnel: your Volvo remains in optimal condition

	List price € excl. VAT	List price € incl. VAT BE	List price € incl. VAT LU	EX60
<b>EXTENDED WARRANTY</b>				
A00139 Volvo Car Extended Warranty + 1 year, limited to 200.000 km	<b>566,12</b>	685	662	O
A00140 Volvo Car Extended Warranty + 2 years, limited to 200.000 km	<b>1.111,57</b>	1.345	1.301	O

O = Option

### VOLVO CAR SERVICE PLAN

**Plan in advance** for a greater peace of mind

Rest assured with Volvo Cars' official maintenance programme. You pay a one-time premium when you sign the Volvo Car Service Plan contract and you no longer have to worry about the maintenance of your Volvo. Our technicians, trained by us, will maintain your car and keep it in perfect condition for years. All parts to be replaced, according to Volvo's official maintenance schedule, are included. So you'll never be faced with financial surprises.

#### VOLVO CAR SERVICE PLAN

- Volvo Car Service according to schedules maintenance intervals
  - health-check
  - software update
- renewal of your Volvo Assistance
- windshield washer fluid top-up 2x/year
- car wash, if available at the chosen Volvo authorised workshop

#### VOLVO CAR SERVICE PLAN PLUS

An extension of the Service Plan that also includes the following wear parts:

- brake pads
- brake discs
- wiper blades

	List price € excl. VAT	List price € incl. VAT BE	List price € incl. VAT LU	EX60
<b>SERVICE PLAN</b>				
XVSW20 Volvo Car Service Plan 1 service, 2 years or 40.000 km	<b>177,69</b>	215	208	O
XVSW22 Volvo Car Service Plan 2 services, 4 years or 80.000 km	<b>475,21</b>	575	556	O
XVSW24 Volvo Car Service Plan 3 services, 6 years or 120.000 km	<b>648,76</b>	785	759	O
XVSW21 Volvo Car Service Plan Plus 1 service, 2 years or 40.000 km	<b>293,39</b>	355	343	O
XVSW23 Volvo Car Service Plan Plus 2 services, 4 years or 80.000 km	<b>698,35</b>	845	817	O
XVSW25 Volvo Car Service Plan Plus 3 services, 6 years or 120.000 km	<b>1.425,62</b>	1.725	1.668	O

O = Option

---

## DELIVERY PACK

---

### VOLVO CAR DELIVERY PACK

Enjoy a **personalized delivery**

The delivery of a new car is a special moment. And Volvo makes this moment even more special. With the Delivery Pack, we provide a personalized unveiling of your new Volvo followed by a detailed explanation during and after delivery. Of course, we make sure your car is fully roadworthy and equipped to enjoy the Volvo experience right away.



- 5 safety vests
- fire extinguisher
- warning triangle
- front numberplate

- car charged to at least 80%
- detailed explanation of all car features
- Volvo Cars app setup

- car delivered under cover with personalized nameplate
- 1 hour follow-up meeting for all your questions after delivery

	List price € excl. VAT	List price € incl. VAT BE	List price € incl. VAT LU
<b>DELIVERY PACK</b>			
DELIV01 Volvo Car Delivery Pack	371,90	450	435

## TECHNICAL SPECIFICATIONS

ENGINE	P6	P10 AWD	P12 AWD
Engine code	E800V31 (NB)	E800V43 (NP)	E800V27 (NA)
Engine type	One electric motor	Two electric motors	Two electric motors
Electric engine battery	Lithium-ion 800 V	Lithium-ion 800 V	Lithium-ion 800 V
Battery energy capacity (nominal) kWh	83	95	117
Battery energy capacity (usable) kWh	80	92	112
Max. capacity kW/hp (rear engine)	275/374	300/408	300/408
Max. capacity kW/hp (front engine)	-	200/272	200/272
Max. torque Nm (rear engine)	480	480	480
Max. torque Nm (front engine)	-	310	310
Emissions standard	EURO 6e	EURO 6e	EURO 6e
<b>TRANSMISSION</b>			
Motricity	RWD	AWD	AWD
Gearbox	Single-speed	Single-speed	Single-speed
<b>PERFORMANCES</b>			
Acceleration 0-100 km/h (sec)	5,9	4,6	3,9
Top speed (km/h)	180	180	180
<b>FULLY ELECTRIC</b>			
Max AC charging (kW)	22	22	22
Max DC charging (kW)	320	370	370
Charge time, 1-phase, AC, from 0 to 100% (32A/16A/10A) 230V (hours)	12/24/41	14/28/47	18/35/55
Charge time, 3-phase, AC, from 0 to 100% (16A/10A) (hours)	8/13	9/15	12/19
Charge time, DC, from 10 to 80% (400 kW/350 kW/150 kW/50 kW fast charger) (min.)	-/16/26/69	16/16/28/79	19/-/-/-
Added driving range after 10 minutes of DC-Charging (km)	300	315	340
<b>CONSUMPTION AND RANGE ACCORDING TO WLTP</b>			
Electric power consumption (combined) kWh/100km	14,9-18,0	16,2-19,2	16,2-19,2
Electric range up to (combined) km	611	660	810
<b>WEIGHTS AND MEASURES</b>			
Min. curb weight (kg)	2.114	2.275	2.330
Running order weight (kg)	2.189	2.350	2.405
Max. total weight (kg)	2.650	2.810	2.860
Max. weight braked/unbraked trailer (kg)	2.000/750	2.400/750	2.400/750
Max. roof load capacity (kg)	100	100	100
Largest load volume with bench seat back folded down ISO V214-1 (incl. V209) (liters)	1.647	1.647	1.647
Largest volume load compartment ISO V214-2 (incl. V209) (liters)	634	634	634
Volume load compartment under luggage cover ISO V211-2 (incl. V209) (liters)	523	523	523
Volume under load compartment floor ISO V209, method VDA/liquid (litres)	63/91	63/91	63/91
Volume Frunk ISO V209, method VDA/liquid (litres)	58/85	58/85	58/85

### FACTORY WARRANTY ON YOUR VOLVO

**3 YEARS OR 100.000 KM**  
(whichever comes first)

### FACTORY WARRANTY ON HIGH VOLTAGE BATTERY\* UP TO

**10 YEARS OR 240.000 KM**  
(whichever comes first)

\* **10-year** or **240.000 km** warranty, provided that the customer has all scheduled regular maintenance carried out within the authorized Volvo network, in accordance with the service intervals and maintenance requirements defined in Volvo Cars' maintenance program. Batteries undergo normal wear depending on age and use. If the battery capacity falls below 70% of its original state, the battery will be replaced under warranty. If all maintenance is not performed within the authorized Volvo network, the warranty is then limited to **8 years** or **160.000 km** (whichever comes first).



## DIMENSIONS

### EXTERIOR

Length x width x height (driver included)	480,3 x 190,8 x 163,9 cm
Wheelbase	297,0 cm
Front track (20" rims - 22" rims)	164,9-165,4 cm
Rear track (20" rims - 22" rims)	163,8-163,9 cm
Turning circle between curbs	11,3 m
Ground clearance (driver included)/foraging depth	17,8/45,0 cm

### INTERIOR

Headroom with sunroof front/rear	104,1 cm/103,0 cm
Shoulder room front/rear	143,7 cm/137,4 cm
Leg room front/rear	105,8/95,1 cm
Length luggage compartment rear seats-tailgate	104,7 cm
Length luggage compartment front seats-tailgate	187,7 cm
Height luggage compartment	78,3 cm
Lifting height	75,3 cm
Width luggage compartment between wheel arches	105,2 cm
Min./max. width tailgate opening	81,2/105,4 cm

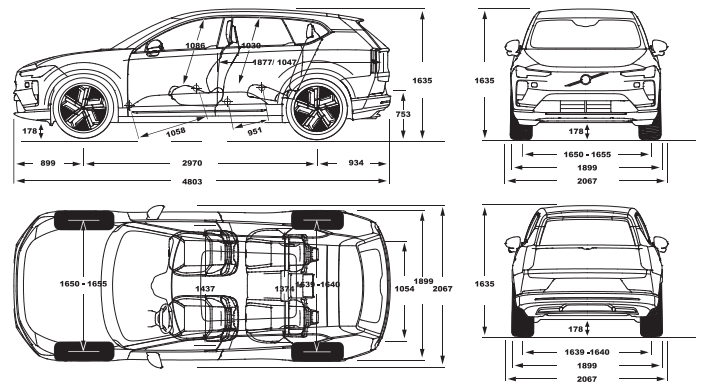



Some of the information in this brochure may be incorrect due to changes to the product specifications introduced after the brochure was published, in particular CO<sub>2</sub> emissions and fuel consumption figures. Volvo Car Belux reserves the right to make changes to the prices, colours, materials, specifications and models at any time without prior notice. The images shown are for information purposes only and may differ from the actual product. Certain equipment, options or accessories described or shown are available at an additional cost. All list prices in this brochure are recommended resale prices. VAT applicable is 21% for Belgium and 17% for the Grand Duchy of Luxembourg. Ask your Volvo distributor for the latest information before ordering.

The availability of the features and services listed in this price list is not guaranteed at the time you take delivery of your EX60. Any missing feature or service will be activated remotely Over-the-Air.

The recommended prices for accessories always include fitting (unless otherwise specified) and (where applicable) Recupel (for Belgium) or Ecotrel (for the Grand Duchy of Luxembourg). Recommended prices for wheel kits (composed of 4 complete wheels with rims and tyres) always include environmental contribution (Recytyre for Belgium), but without fitting and software update (if needed).

Environmental contribution included.

This offer is binding on Volvo Car Belgium NV and/or its affiliated companies only to the extent that the Standard General Terms and Conditions and the relevant Commercial Conditions are fully applicable, and the applicability of your general terms and conditions or any other terms is entirely excluded.

A 4-year data subscription for use of Google services and all apps is included in the retail price of the car. After that period, a paid extension of the data subscription will be available or you can share your data via your smartphone.

Environmental information [Royal Decree 19/03/2004]. All self-respecting Volvo drivers put safety first.  
R.P.: Florent Andrieu - Volvo Car Belgium nv - John Kennedylaan 25, B-9000 Gent - VAT no.: BE 0420.383.548  
Place of business: Volvo Car Belux - Hunderenveldlaan 10, B-1082 Sint-Agatha-Berchem

**V O L V O**

VOLVOCARS.BE/LU  
2026 - V03.MY27

