

U.S. Technical Highlights

2025 Volvo V60 Polestar Engineered

V O L V O

Electric range* (in pure mode)	41 mi
Combined range*	530 mi
Fuel economy* (combined)	74 MPGe
Battery capacity	18.8 kWh
Battery capacity (usable)	14.7 kWh
Power, total	455 hp
Power, electric	143 hp
Power, engine	312 hp
Torque	523 lb-ft
Drive type	AWD
0-60 mph	4.3 sec
Largest luggage volume	60.5 ft ³
Curb weight	4,500 lbs

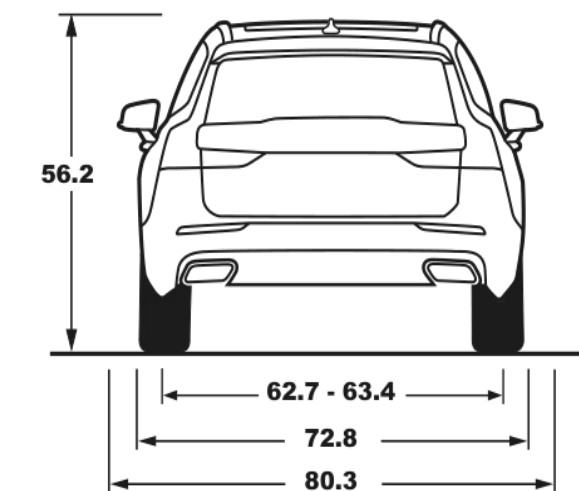
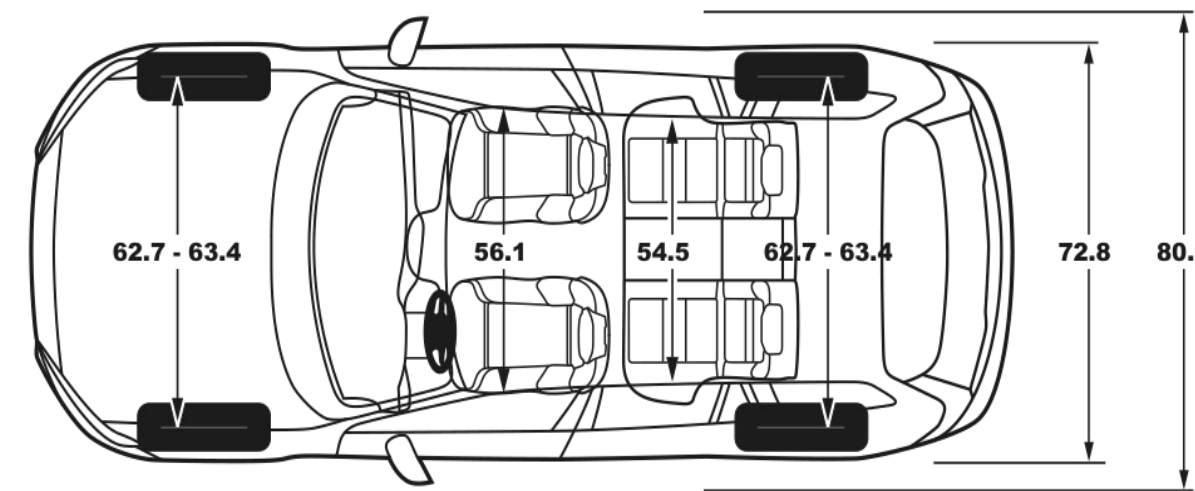
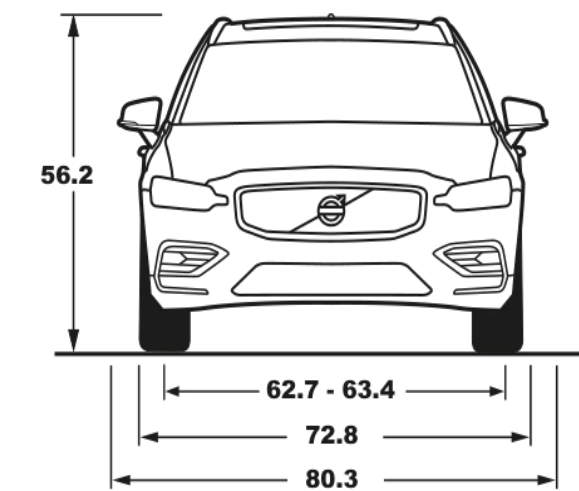
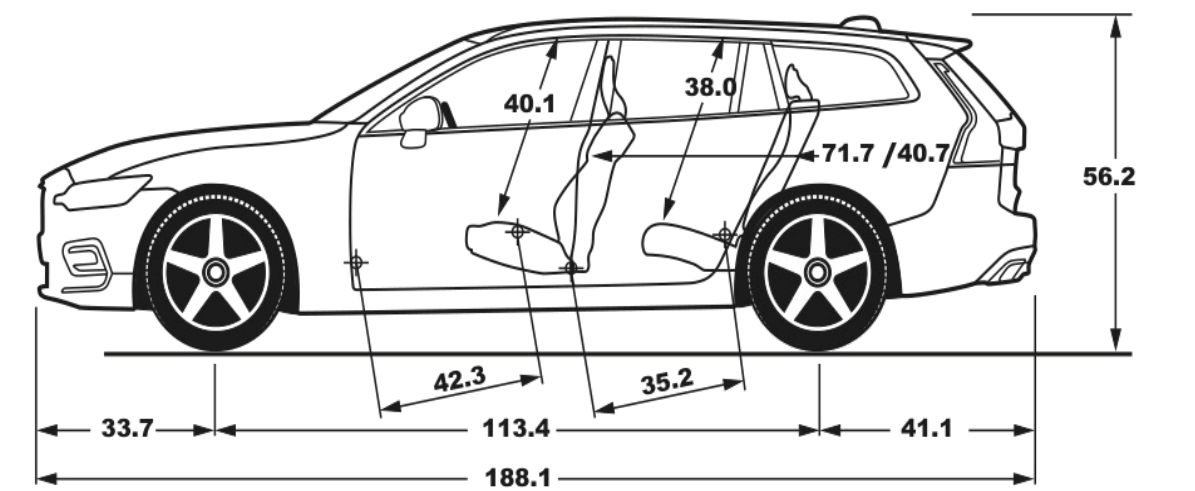

*Range is according to EPA driving cycles and real-world range may vary.

* EPA estimated range is 30 MPG city/33 MPG highway/74 MPGe combined. Your actual range will vary for many reasons, including but not limited to, driving conditions, how and where you drive, how you maintain your vehicle, battery-package/condition, and other factors.